

AEROELASTIC LOAD SELECTION BASED ON ELEMENTS INDICES

K. Bramsiepe, M. Herberhold, A. Voß, Deutsches Zentrum für Luft- und Raumfahrt e. V.
 Institut für Aeroelastik, Bunsenstraße 10, 37073 Göttingen, Deutschland

Abstract

Background: For the preliminary aircraft design, the loads of a configuration have to be analyzed for several load cases and the structure is optimized for minimum weight. The load selection between the load analysis and the structural optimization determines the calculation time. The less critical load cases are identified, the faster is the optimization.
Objective: Thus, a new method is tested at a conventional tail-aft configuration in order to investigate the reduction of critical load cases towards the final result and the computational effort.
Method: The new method based on finite elements calculates the failure indices for each element for each load case. The highest failure index of an element identifies the critical load case.
Simulation Model: To analyze the new method on a conventional tail-aft aircraft, the XRF1-DLR-C is utilized. It is a full composite FE-model which was developed from the data set of the XRF1 of Airbus.
Results: The identified load cases and the calculation time are reduced while the results change only marginally.

1. INTRODUCTION

In the scope of aeroelastic design, the most important steps are load analysis and structural optimization. Between these steps the load selection process is located. It identifies critical load cases which have to be considered in the optimization. According to Wright and Cooper [1], a critical load case in aircraft design is a load case that dictates a dimension of a part of the aircraft structure. This means, a critical load case creates the maximum load in that part of the structure and thus determines the minimum structural dimensions necessary to prevent the structure from failing. All non-critical load cases have no influence on the structural dimensions.

In our previous work, we developed a new method (Fig. 1) to identify critical load cases. The new method is called "method on the finite element level" [4].

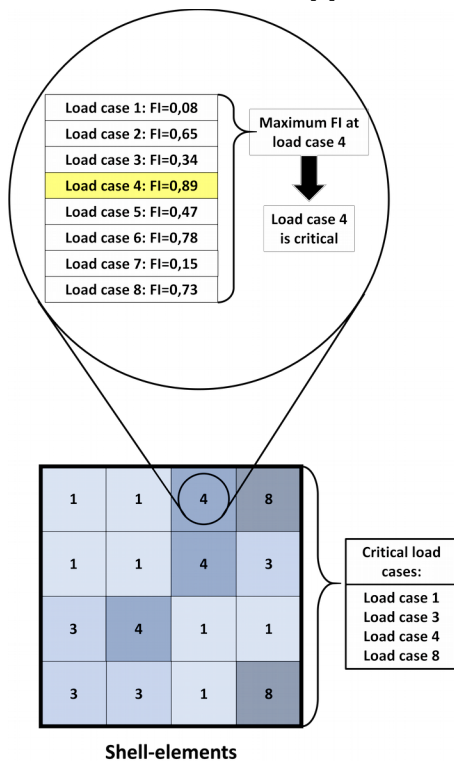

Figure 1: Identification of critical load cases with the new method on the finite element method [4]

At first, this method was implemented into the preliminary design process of the flying wing MULDICON [5]. The results were compared to the results of the preliminary design process using the classical cutting loads method (Fig. 2). The reason for this comparison were concerns, that the classic cutting loads method might not be able to identify all critical load cases in planar and indeterminate structures like a flying wing. These concerns could not be confirmed, but the new method was able to reduce the number load cases identified as critical by 50% without any visible impact on the optimization results. Beyond this, the method is independent from the shape of the structure and evaluates the load cases in more detail. It also offers extensive options for visualization and interpretation, which make it possible to visualize load paths and identify highly loaded structural areas in the preliminary design process.

To investigate, if the reduction of critical load cases and calculation time could be replicated, the method on the finite element level has to be tested in the design process of different aircraft configuration. So in this work, the new method is applied to a conventional tail-aft aircraft. In the following section the two load selection methods are introduced. Then, the design process, the simulation model XRF1-DLR-C and the extension of the design process are described. This is followed up by the results section and the conclusion.

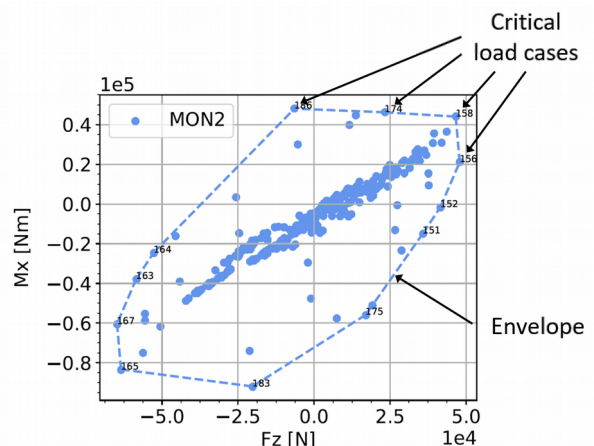

Figure 2: Identification of critical load cases with the classical cutting loads method [4]

2. IDENTIFICATION OF CRITICAL LOAD CASES

Due to the complexity of modern design envelopes and aircraft structures, it is often not obvious if a load case is critical or not. If it is possible to identify all dimensioning load cases, only these load cases must be considered in the preliminary aircraft design. Every non-critical load case that is included into the preliminary design increases the amount of work and time required for the design process. In contrast, every critical load case that is not included into the preliminary design decreases the quality of the design and could even lead to an unexpected structure failure. Therefore, it is desirable to find an identification method that identifies the least possible number of non-critical load cases, but every critical load case.

Since non-critical load cases have no effect on the structural dimensions, a structural optimization should get the same results with a reduced set of load cases as long as it still includes all critical load cases. This limit can be used to test, if a method is able to identify all critical load cases.

2.1. Identification of critical load cases with monitoring stations

The classic preliminary aircraft design process uses the cutting loads method [1]-[3] to identify critical load cases. For this method, it is necessary to determine the cutting loads for every load case on several monitoring stations distributed over the aircraft structure. In this work the cutting loads are calculated at monitoring stations by integrating all nodal loads. On every monitoring station the cutting loads of every load case are processed into several two-dimensional scatter plots. Every scatter plot considers two of the six cutting load components. The scatter plot is then enveloped by a convex hull (see Fig. 2). Every point on the envelope is a combined maximum or minimum of the two plotted cutting load components. The load cases that cause these maxima and minima are identified as critical load cases. This process is repeated at every monitoring station.

If every combination of the six cutting load components is considered, 15 scatter plots and envelopes are necessary for every monitoring station. Usually not every cutting load component is relevant in every aircraft section, in the wing section for example only the vertical lateral force F_z , the bending moment M_x and the torsion Moment M_y are significant. This reduces the number of necessary scatter plots to only three. This work only considers the three mentioned cutting load components.

The cutting loads method is an automated process and is integrated in the load computation. The method is able to process thousands of load cases in just a few minutes.

2.2. Identification of critical load cases on the finite element level

The new method is based on the finite element analysis (FEA) and identifies the critical load cases directly from stresses or strains on the finite element level. At first, a linear static FEA, more precisely MSC.Nastran SOL101 [6], calculates the stresses or strains in every element for every load case. These stresses or strains, a matching failure hypothesis [7], and the material properties of the element are then used to calculate a failure index of every element and for every load case. The failure indices of every load case are then compared within one element and the load case, which generates the highest failure index, is identified as a critical load case. This process is repeated for every element. It is not relevant if a load case is identified in one or more elements. (see Fig. 1).

As the method identifies a critical load case in every element, load cases are also identified in elements with low maximum failure indices. The load cases, that cause these overall low but locally highest failure indices, often also cause only low failure indices in the rest of the structure and are therefore non-critical load cases. Overall this leads to huge number of non-critical load cases identified as critical. Filtering out elements with a low maximum failure index reduces the number of falsely identified non-critical load cases without overlooking actual critical cases. Due to this the method was coupled with a filter, which filters out all elements with a maximum failure index below a certain threshold.

For the MULDICON a threshold of 0.3 reduced the number of identified load cases in average by 50% compared to the number of critical load cases identified by the cutting loads method. The reduction had no impact on the results of the preliminary design process, but was able to reduce the calculation time. The determination of reasonable values for the failure index thresholds is not trivial, especially for more complex hypothesis like IJsselmuideren. Therefore, instead of an adjustable threshold an adjustable multiplication of the stresses or strains is used. The failure indices are calculated twice, once in the usual way with the unchanged stresses or strains and once with all stresses or strains multiplied by the adjustable reserve factor. The second failure index is then compared to the fixed limit of one. If it is below 1 the load case will be ignored in the specific element. If all reserve failure indices in an element are below 1 the whole element won't be considered in the identification of critical load cases. A test on the MULDICON with a reserve factor of 1.83, equivalent to the previously used threshold of 0.3, showed, that this filtering method has no impact on the identified load cases, but is easier to handle and more versatile.

This method is highly automated and it is possible to implement new or custom failure hypothesis for strain and stress. It is able to analyze metal and composite materials and can use a ply-by-ply or black-metal approach for composites. It is also able to handle different materials in the same model and can use different failure hypothesis for each material. This makes it possible to use the method on the finite element level on a huge number of MSC.Nastran shell-models.

3. DESIGN PROCESS cpacs-MONA

For the preliminary design of the XRF1 the parametric aeroelastic design process cpacs-MONA [8] is used. The name of this DLR in-house process is derived from the two main tools ModGen and MSC.Nastran. Some examples of usage are the configurations FERMAT [9], ALLEGRA [10], DLR-F19 [11] and MULDICON [5]. The parametric aeroelastic design process can usually be split into three main steps as shown in Figure 3.

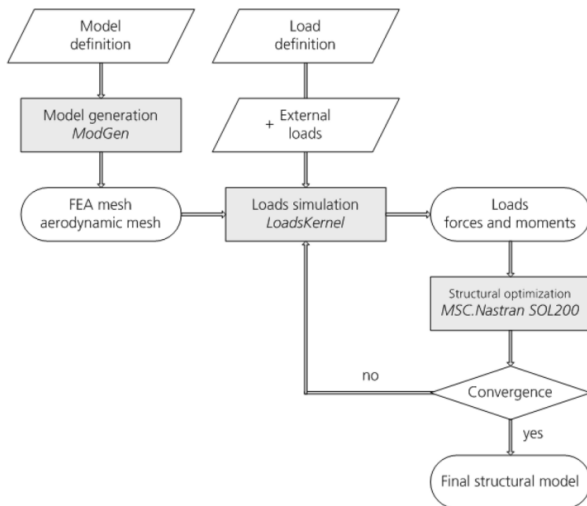

Figure 3: Parametric design process MONA with LoadsKernel [5]

The first step is model generation with the DLR in-house Tool ModGen. The tool is able to generate parametric FE-models for given aircraft configurations. The tool needs basic information about the aircraft geometry, like the planform, the aerodynamic profiles and their positions along the wing. Furthermore, the geometry of the wing box with the positions of ribs and spars needs to be defined. Using analytic functions, a geometric model is generated from the input data. With suitable meshing parameters, a finite element model mostly consisting of shell elements is derived. In addition, several other models can be generated by the tool for example, mass models containing system, structure, and fuel masses. Optimization models can also be created by defining an objective function (total structure mass), design variables (skin thickness), and constraints (e.g. failure indices). Additionally, for the wings, the fuselage and the tailplane a mesh for the aerodynamic panel method is generated. All models are written into MSC.Nastran readable data formats.

In the second step, loads simulation, the DLR tool LoadsKernel [12] is used. This tool calculates the dynamic and quasi-static loads which act on the aircraft structure during maneuvers. The LoadsKernel needs the aerodynamic and structural meshes as well as the mass and stiffness matrices of the aircraft. In addition, the flight cases to be analyzed need to be defined. These cases are split into the three categories: maneuvering cases, gust cases, and landing cases. From the inputs the inertia and aerodynamic loads for an elastic structure are calculated

for each load case. In this work, a total of 216 maneuvering cases are simulated. In a post-processing step the cutting loads method (see chapter 2.1) is used to identify the critical load cases. The cutting loads are calculated at six monitoring stations along the wing. Finally, the corresponding nodal loads acting on the structure and the critical load cases are written into MSC.Nastran readable files.

The third and final step is the structural optimization carried out by MSC.Nastran's SOL200 [6]. Applying the critical loads to the structure, MSC.Nastran SOL200 calculates the failure indices for each shell element and each load case with a static analysis. Furthermore, the sensitivities of the objective function and the constraints with respect to the design variables are calculated. Then the structure is optimized using a gradient-based algorithm, targeting a minimal structural weight. This iterative process is repeated, until convergence is achieved.

4. MODEL DESCRIPTION OF THE XRF1-DLR-C

The XRF1 configuration (see Fig. 4) is a generic wide body configuration developed by Airbus. The eXternal Research Forum (XRF) is used as a research platform for collaboration purposes between Airbus and research institutions and universities. At DLR the XRF1 configuration is used since 2008 (ARTEMIS project) as application of MDO processes in various projects. The cpacs data set was recalculated by DLR preliminary design tools [13]. The structural model of the XRF1-DLR-C [14], as a result of an extended cpacs-MONA process, is an MSC Nastran finite element model for the complete aircraft with composite material that can be used for static, dynamic, and aeroelastic analysis as well for further structural design tasks.

The center of gravity range is defined between 15% - 40% mean aerodynamic chord. Further geometrical data and the basic design masses are given in Table 1. The chosen mass configurations for the loads analysis are depicted in Figure 5. Payload- and fuel masses are modeled with distributed concentrated mass items. They depend for the fuel on the filling levels of the used fuel tanks and for the payload on the amount and distribution of payload and passenger within the fuselage.

The lower skin has a minimum thickness of 8 mm between root and engine while the remaining lower skin has a 6 mm minimum. All other parts have a minimum of 4 mm. Ply properties for IM6 are given in [15]. The aerodynamic forces are simulated with VLM (Vortex-Lattice Method) [16]. Figure 8 shows the DLM boxes of the lifting surfaces and the cross-body used for the fuselage aerodynamics. In Figure 6 the global finite element model is shown. The monitoring stations for the classical cutting loads method are shown in Figure 7. The optimization model is capable of composite layer optimization with lamination parameters. In this work, a fixed lay-up is used to simplify the optimization and just the skin thicknesses are optimized. The XRF1-DLR-C is divided into 82 design fields as shown in Figure 9 for the upper skin elements.

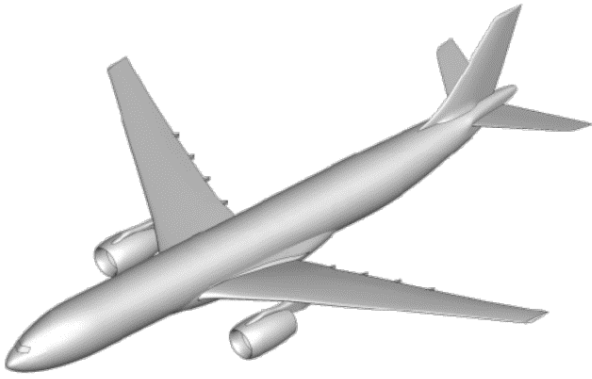

Figure 4: The XRF1 configuration [13]

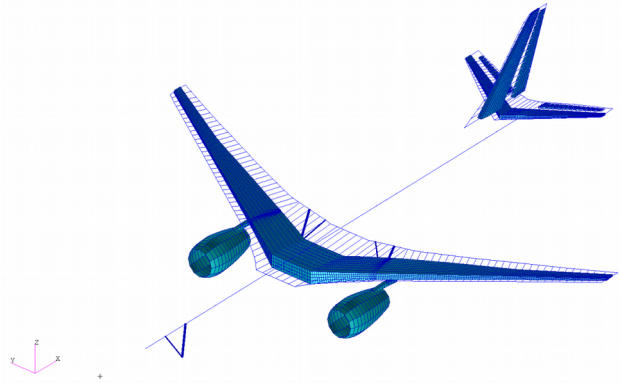

Figure 6: The FE-Model of the XRF1-DLR-C [14]

Table 1: Basic geometrical parameter of the XRF1-DLR-C

Item	XRF1-DLR-C
Wing area [m ²]	361.1
Span [m]	61.1
Reference cord [m]	7.6
Wing sweep [°]	29.7
Fuselage length [m]	63.9
Fuselage diameter [m]	5.6
OWE / MZFW / MTOW [t]	130.3 / 180.5 / 245.0

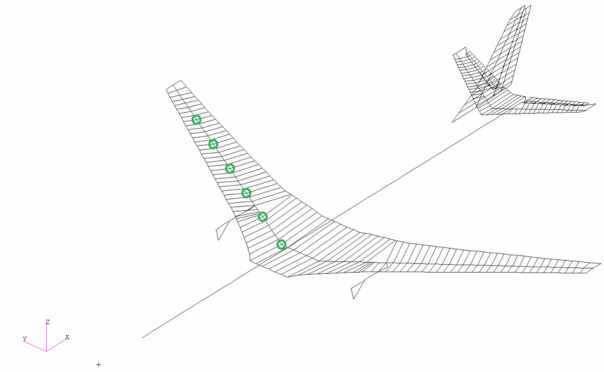

Figure 7: Condensed FE-Model of the XRF1-DLR-C with monitoring stations [14]

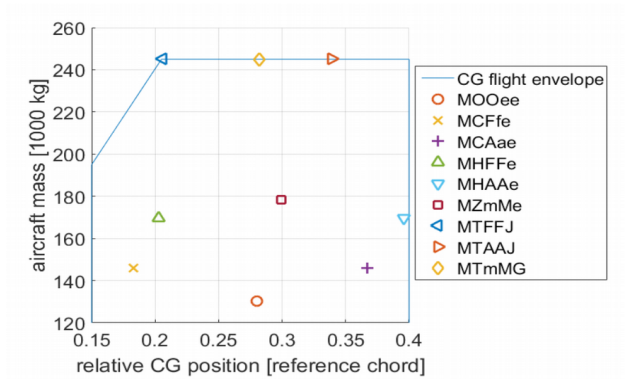

Figure 5: Mass envelope of the XRF1-DLR-C [14]

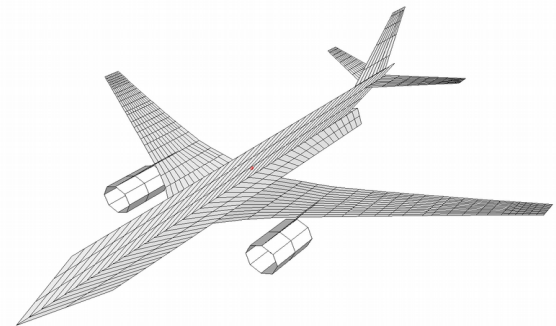

Figure 8: The DLM-Model of the XRF1-DLR-C

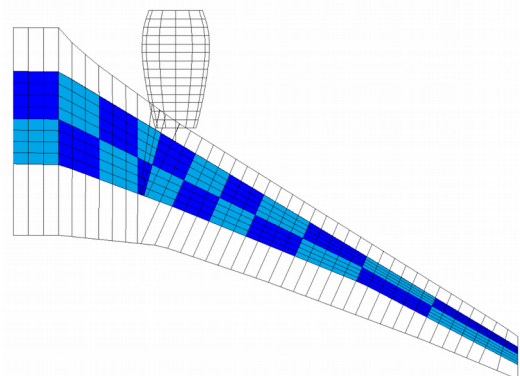

Figure 9: Design fields for the XRF1-DLR-C [14]

5. OPTIMIZATION OF THE XRF1-DLR-C WITH BOTH METHODS

Two optimizations of the XRF1-DLR-C are performed to investigate if the method on the finite element level is beneficial.

The first optimization uses the standard design process as described in Chapter 3 with the classical cutting loads method. The second optimization uses the new method based on the finite element level to identify the critical load cases. For this, two additional steps need to be implemented into the cpacs-MONA design process as seen in Figure 10. After the loads calculation with the LoadsKernel, a linear static FE-analysis using MSC.Nastrans SOL101 needs to be conducted. This analysis includes all load cases and calculates the stresses and strains in every element of the structure. Then the method on the finite element level is run and the critical load cases are identified. These critical load cases are used for the structural optimization and the standard MONA design process continues. The two steps take 5 minutes of additional calculation time. Overall, four optimization cycles (loadloop 0 to loadloop 3) were conducted with each method.

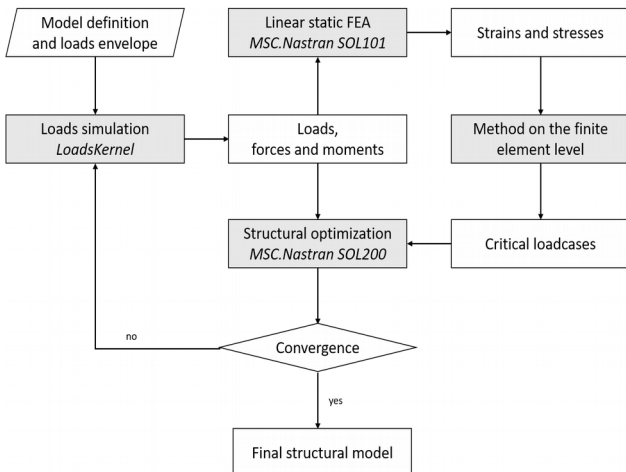

Figure 10: Parametric design process MONA with the method on the finite element level [4]

The set of load cases for the optimization consist of 216 maneuvers from the CS-25 maneuver envelope [17]. The maneuvers consist of a basic set of 24 maneuvers with nine velocities between Mach 0.42 and Mach 0.93, three altitudes (0ft, 10,000ft and 25,000ft), and 2.5g-Pull-Up, -1g-Push-Down, Level flight, Roll and Yaw maneuvers. This basic set is repeated for all nine mass configurations.

The optimization is conducted with the 82 variables for the skin thicknesses of the design fields, 3 constraints for every element (maximum strain of tension, compression and shear), and the goal of reducing structural weight. In this work, buckling of the plates is not considered to reduce the complexity of the optimization. The initial skin thicknesses are given by a preliminary cross section sizing for composites.

The selected critical load cases are given in Table 2 for both methods of the first loads simulation. The number of critical load cases is reduced significantly. For the 2.5g Pull-up maneuver and for the cruise flight maneuver the

new method identifies one additional critical load case which has not been identified by the cutting loads method.

Table 2: Load case selection before the first optimization of loadloop 0

Item	Cutting loads method	FE-based method
Design load cases	61	14
2.5g Pull-up	17	8 (+1)
-1.0g Push-down	24	1
Roll maneuver	31	3
Yaw maneuver	8	0
1.0g Cruise flight	0	0 (+1)

6. RESULTS

In this section, the reduction of critical load cases and the occurrence of new critical load cases are investigated. Furthermore, the new possibilities of the visualization part are addressed.

The reduction of 61 load cases to 14 (-77%) can easily be explained by Figure 11. It shows the loads envelope of the monitoring station at rib 28 for M_x and M_y . The green marked edge points of the envelope are identified as critical by both methods. The red-crossed points are just identified by the cutting load method. These load cases with lower absolute values have no influence on the structure optimization. However, it is not possible to take just the maxima of both cutting load components, because some load combination can lead to a critical failure index like load case 156, a roll maneuver.

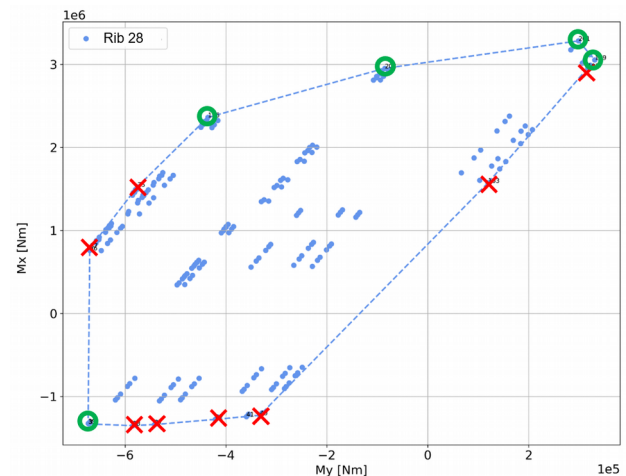

Figure 11: Cutting loads at monitoring station Rib 28, Green mark: Identified by both methods, Red mark: Reduced by the new method

This reduction has also an influence on the calculation time. The structural optimisation needs 50% less time per iteration. In Table 3 the calculation time per iteration of each loadloop is presented.

Table 3: Calculation time of the loadloops per iteration

	Cutting loads method		FE-based method	
	Time/iteration	iterations	Time/iteration	iterations
Loadloop 0	1:54:35	19	0:55:57	63
Loadloop 1	1:10:36	67	0:43:35	34
Loadloop 2	1:23:06	32	1:35:12	18
Loadloop 3	1:11:06	27	0:34:35	34
Sum	1:24:50	145	0:57:20	149

The difference in loadloop 2 of the new method is connected with a low number of iterations in that calculation. This can happen at local minima when the constraints are fulfilled and the changes of the variables are low. The same can be seen in loadloop 0 of the classical method. However, the reduction of calculation time per iteration is significant.

In particular, the new method recognize two additional critical load cases. These two load cases become active in two elements between the monitoring stations at rib 10 and rib 16 during loadloop 0 (see Fig. 12). In the following loadloops no other load case is identified additionally. Anyhow, peak loads, which may arise as a critical load, can be identified by the new method.

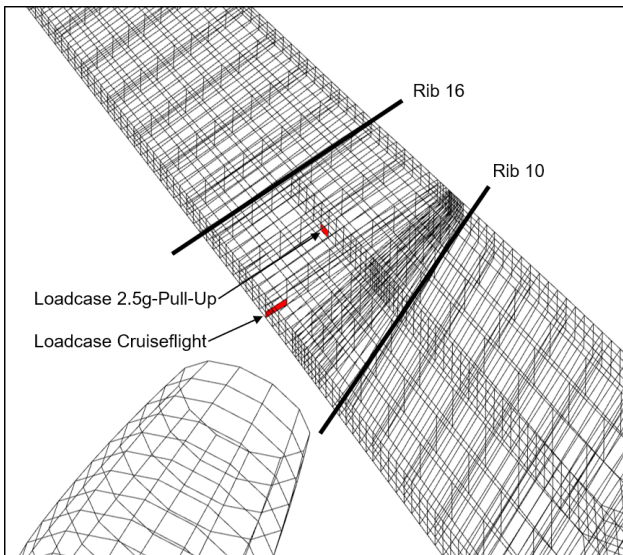

Figure 12: Detailed view of the two additional identified load cases between rib 10 and rib 16

As a valuable side effect, the visualization possibilities can help to analyze the load cases in more detail. Throughout the process, the specific load case, which is dimensioning the structure, can be shown at each element. Which load case is where active and where violating the constraints. For this load set it is visualized in Figure 13.

The most of the wing structure is sized by one load case. It is a 2.5g-Pull-up maneuver load case of the MTOW configuration with the most forward positioned center of gravity at the highest flight level. Figure 14 shows each element where this specific load case is sizing the structure. With this information other disciplines can perform a fast optimization of the wing.

The visualization options are also possible for more comprehensive load sets which includes also gust loads and landing loads. In a first loop, it is shown in Figure 15. The analysis is conducted with the maneuver and gust load alleviation from Handojo [18].

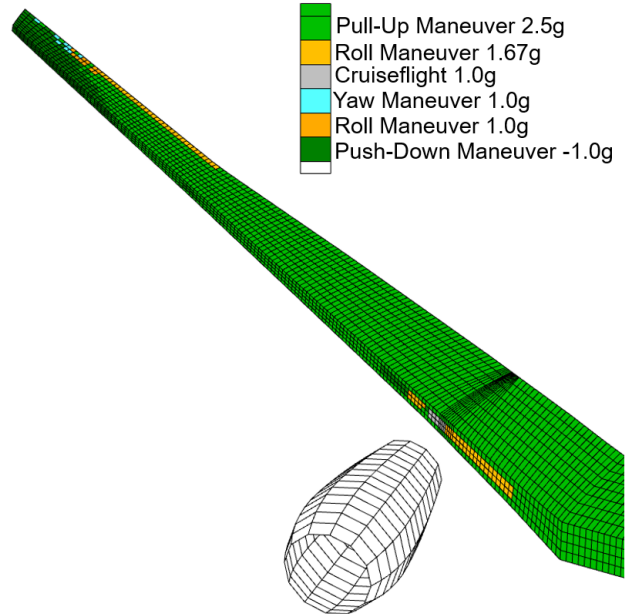

Figure 13: Load cases with the highest failure index for each element

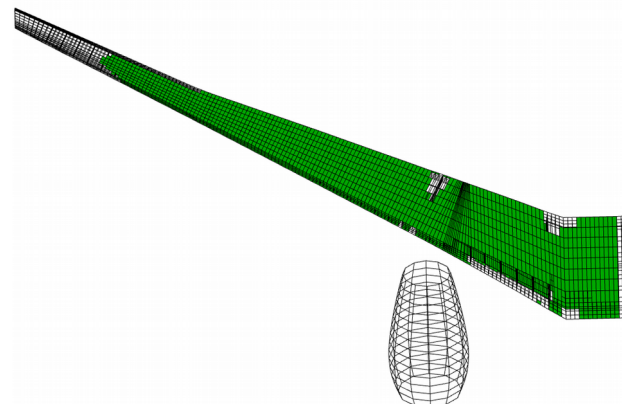

Figure 14: Every element where load case 201 has the highest failure index

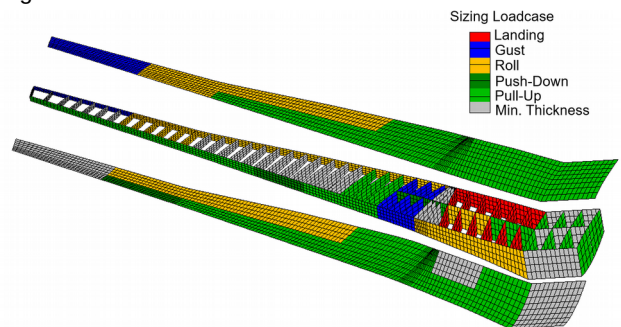

Figure 15: Sizing load cases of a comprehensive load set with landing, gust, and maneuver cases and with maneuver and gust load alleviation

7. CONCLUSION

In this work, the new method for load case selection based on finite elements is successfully used for the optimization of a conventional tail-aft aircraft. The design load cases can be reduced by about 75% and the calculation time of the structural optimization is halved per iteration. Peak loads can be analyzed with the new method and are transmitted to the optimization. The visualization helps to understand load paths and load case hierarchies easier. In future, the visualization procedures will be used for other aeroelastic optimizations and the load case selection will be used to reduce the set of load case for other disciplines. To finally use this method in aeroelastic design it has to be extended to account also failure indices of buckling analyses.

8. ACKNOWLEDGMENTS

We would like to acknowledge the funding by the Deutsche Forschungsgemeinschaft (DFG, German Research Foundation) under Germany's Excellence Strategy - EXC 2163/1 - Sustainable and Energy Efficient Aviation - Project-ID 390881007.

9. LITERATURE

- [1] Wright, J. R., and Cooper, J. E., "Introduction to aircraft aeroelasticity and loads", Second edition. Chichester, West Sussex, England: Wiley, 2014.
- [2] Huxel, M., "Vergleich von Verfahren zur Identifikation von kritischen Entwurfslastfällen an hochintegrierten Flugzeugkonfigurationen", Masterthesis, TU Munich, Munich, Germany, 2019.
- [3] Voß, A., "Design and Structural Optimization of a Flying Wing of Low Aspect Ratio Based on Flight Loads", Dissertation, TU Berlin, Göttingen, 2020. <http://dx.doi.org/10.14279/depositonce-9858>
- [4] Herberhold, M., "Identifizierung dimensionierender Lastfälle auf Ebene finiter Elemente an einer Nurflügelstruktur im Vergleich zur Schnittlastmethode", Bachelorthesis, HAW Hamburg, Hamburg, Germany, 2020.
- [5] Bramsiepe, K., Voß, A., and Klimmek, T., "Design and sizing of an aeroelastic composite model for a flying wing configuration with maneuver, gust, and landing loads", CEAS Aeronautical Journal, April 2020. doi: 10.1007/s13272-020-00446-x
- [6] MSC Software Corporation, "MSC Nastran 2018.2 Reference Guide", MSC Software Corporation, USA, 2018.
- [7] H. Schürmann, "Konstruieren mit Faser-Kunststoff-Verbunden" Springer-Verlag, Berlin, 2007.
- [8] Klimmek, T., Schulze, M., Abu-Zurayk, M., Ilic, C., Merle, A., "cpacs-MONA – An independent and in high fidelity based MDO tasks integrated process for the structural and aeroelastic design for aircraft configurations", IFASD, Savannah, USA, 2019.
- [9] Klimmek, T., "Parametric Set-Up of a Structural Model for FERMAT Configuration for Aeroelastic and Loads Analysis", J. Aeroelasticity Struct. Dyn., No. 2, May 2014, doi:10.3293/asdj.2014.27
- [10] Krüger, W. R., Klimmek, T., Liepelt, R., Schmidt, H., Waitz, S., and Cumnuantip, S., "Design and aeroelastic assessment of a forward-swept wing aircraft", CEAS Aeronautical Journal., Vol. 5, No. 4, pp. 419–433, Dec. 2014, doi: 10.1007/s13272-014-0117-0.
- [11] Voß, A., and Klimmek, T., "Design and Sizing on a Parametric Structural Model for a UCAV Configuration for Loads and Aeroelastic Analysis", CEAS Aeronautical Journal, Vol. 8, pp. 67–77, 2017.
- [12] Voß, A., "Loads Kernel User Guide", DLR-IB-AE-GO-2020-136, Göttingen 2020. <https://elib.dlr.de/140268/>
- [13] Kroll, N., Abu-Zurayk, M., Dimitrov, D., Franz, T., Führer, T., Gerhold, T., Görtz, S., Heinrich, R., Ilic, C., Jepsen, J., Jägersküpper, J., Kruse, M., Krumbain, A., Langer, S., Liu, D., Liepelt, R., Reimer, L., Ritter, M., Schwöppe, A., Scherer, J., Spiering, F., Thormann, R., Togiti, V., Vollmer, D., and Wendisch, J.-H., "DLR project Digital-X: towards virtual aircraft design and flight testing based on high-fidelity methods," CEAS Aeronautical J., Vol. 7, No. 1, Dec. 2015, pp. 3–27, doi: 10.1007/s13272-015-0179-7.
- [14] Bramsiepe K., Handojo, V., Meddaikar, Y. M., Schulze, M., and Klimmek, T., "Loads and Structural Optimization Process for Composite Long Range Transport Aircraft Configuration", presented at 2018 Multidisciplinary Analysis and Optimization Conference, Atlanta, Georgia, June 2018, doi: 10.2514/6.2018-3572.
- [15] S. T. IJsselmuiden, M. M. Abdalla, und Z. Gürdal, "Implementation of Strength-Based Failure Criteria in the Lamination Parameter Design Space", AIAA Journal Vol.46, No. 7, July 2008.
- [16] Voß, A., "An Implementation of the Vortex Lattice and the Doublet Lattice Method", DLR-IB-AE-GO-2020-137, Göttingen 2020. <https://elib.dlr.de/136536/>
- [17] EASA, "Certification Specifications for Large Aeroplanes CS-25". 2003.
- [18] Handojo, V., "Contribution to Load Alleviation in Aircraft Pre-design and Its Influence on Structural Mass and Fatigue", Dissertation, TU Berlin, Germany, 2021. <https://elib.dlr.de/139558/>