

THE DECAN PROJECT AT TU BERLIN

T. Nitschke, J. Kolbeck, R. Wolf, R. A. Court, P. Wüstenberg, E. Melan, M. Schmid
Technische Universität Berlin, Marchst. 12, 10587 Berlin, Berlin, Germany

Abstract

This document describes the current development status of the DECAN rocket project at the Technische Universität Berlin. Therefore, the hot water lower stage of the rocket, as well as the solid propellant upper stage, are presented. Moreover, the development of one of the DECAN's new components will be introduced, the Safe and Arm Device. The two-stage sounding rocket serves as practical example for the development team and improves their knowledge in a variety of engineering fields. In October 2015, the engineering qualification model and flight model of the DECAN upper-stage will be launched as single stage rockets from ESRANGE, near Kiruna, in Sweden.

1. INTRODUCTION

The DECAN program (DEutsche CANSat-Höhenrakete) is a student project within the framework of the STERN (STudentische Experimental-RaketeN) project of the DLR Space Administration. Engineering students get the opportunity to work on a real aerospace project under professional supervision. The different phases of the project follow the ECSS guidelines and are frequently reviewed together with the DLR.

This paper will describe the current development of the rocket at the Technische Universität Berlin. The different subsystems will be presented and the status of the project will also be described. As of now, the DECAN team has successfully accomplished the goals set for the rocket acceptance review (RAR) and is currently moving forward with the defined timeline, leading up to the launch of the upper stage rocket from ESRANGE, nearby Kiruna at the end of 2015. The lower stage will be launched early 2016. A two-staged rocket will be launched in a follow-up project phase. In the last few months, the DECAN team designed a Safe and Arm Device for the DECAN system. The design includes the flight segments as well as the ground segments. Several designs were discussed and the results will be shown in this paper.

2. TWO-STAGE ROCKET ARCHITECTURE

The rocket consists of a two stage rocket with a take-off mass of less than 150 kg. DECAN will be capable of launching a CanSat to an altitude of up to 7 kilometers. The first stage is comprised of a hot water propulsion system developed at TU Berlin. The water will be heated to over 250 °C, producing a pressure of ca. 50 bar inside the vessel. After the release of the rocket, the lower stage will produce an average thrust of 3 kN for a brief amount of time. The second stage of the rocket has a solid rocket motor. This stage carries the main payload, which will be a CanSat. Figure 3 shows the current development status of DECAN. Both stages have been configured in such a way as to allow them to be flown independently from each other. The relatively small altitude of the lower stage (less than 1 kilometer) assures the usage of nearby launch pads. Hence, hardware and software components can be tested frequently. The nose cone in the image contains the inter-stage adapter for when a two-stage configuration is desired.

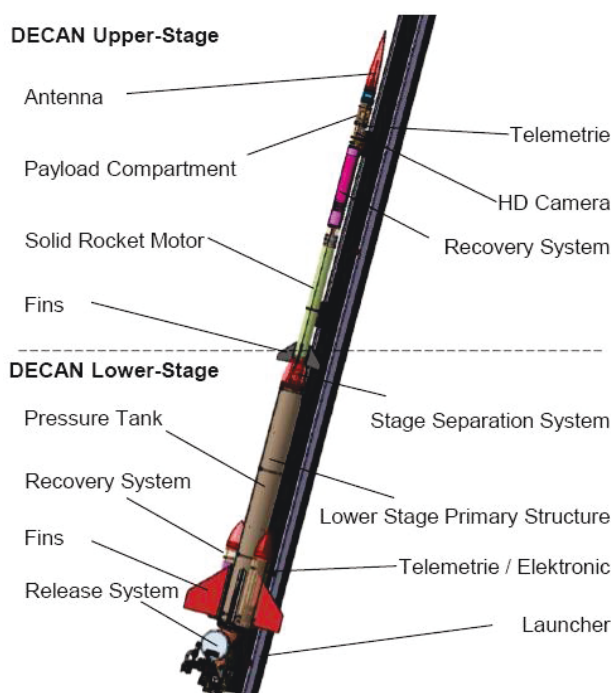

Figure 1 DECAN two-stage rocket and its main components.

Both stages possess recovery systems in order to ensure reusability. The lower stage recovery system is designed to carry both rockets, in the case of a malfunction of the stage separation system.

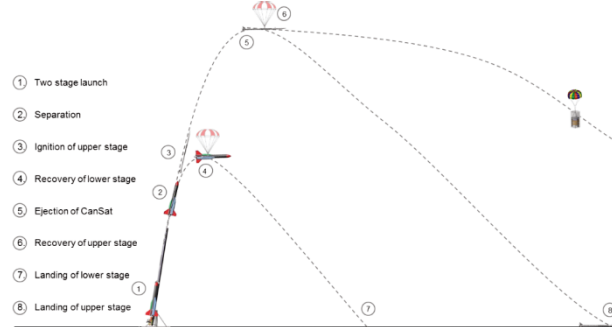

Figure 2 DECAN Mission Concept

Figure 2 shows the mission concept of DECAN two-stage sounding rocket. After release of the rocket, the exhaust (hot water) accelerates the two-stage rocket. At the end of the accelerating phase, the lower stage will be separated (2) and the upper stage solid rocket motor will be ignited (3). The upper stage transports the CanSat payload to a peak altitude of 7 km. At apogee, the payload will be ejected (5). Both stages, as well as the payload, will return with the support of a recovery system (4) (6) safely to the ground (7) (8).

3. LOWER STAGE

As introduced earlier, the lower stage aims at increasing the overall altitude of the two-staged sounding rocket. As a result, the payload may be released from a higher altitude and therefore collect more scientific data. Due to the comparably low altitude of a single lower stage configuration, more frequent launches in Germany are possible in order to test components used for either stages.

The propulsion system design is based on experience gained from the TU Berlin AQUARIUS project which has been optimizing hot water propulsion systems for over two decades. During the heat-up phase, both pressure and temperature can be monitored for safety reasons. Several safety mechanisms were included in collaboration with the TÜV to provide a safe working environment. Once the release system is triggered, the water jet is ejected and evaporates immediately within the nozzle due to lower external pressure. A maximum thrust of 3000 N is provided for approximately 3 seconds.

The rocket structure is mounted to the vessel with frictionally engaged retaining rings. Hence the vessel is not weakened and the rocket can be assembled easily. As seen in Figure 3, four equally spread fins enable a passive aerodynamic stabilization and are connected to the rings. Two compartments provide space for a suitable recovery system, electronic subsystems and optional payload. They are mounted to the rings as well. The recovery system is designed to recover both stages in case of a faulty stage separation. The load-bearing parachute rope is wired to the retaining rings and redundantly secured. An On-board computer measures all relevant flight parameters such as acceleration, and height. It also transmits collected data to the ground via downlink. Once the apogee is reached, the board computer triggers the actuator to release the recovery parachute which is inflated by the help of a smaller auxiliary parachute. A pre-stressed spring mechanism helps to release the parachutes. An optional payload may be included in the electronics compartment. The electronics determine the rocket orientation, measure temperatures, the altitude, and the rocket's position. All data will be transmitted to ground via 3G network or W-LAN.

In order to ensure the personnel's safety who are working around the rocket, the S&A-Device may also be integrated into the lower stage. It will be located in the electronics

compartment and works as an interface to disarm and arm all electronics prior to the start. The flight segment of the S&A is actuated at a ninety degree angle from the ground segment to take away pressure from the primary structure (shown in chapter 5.1).

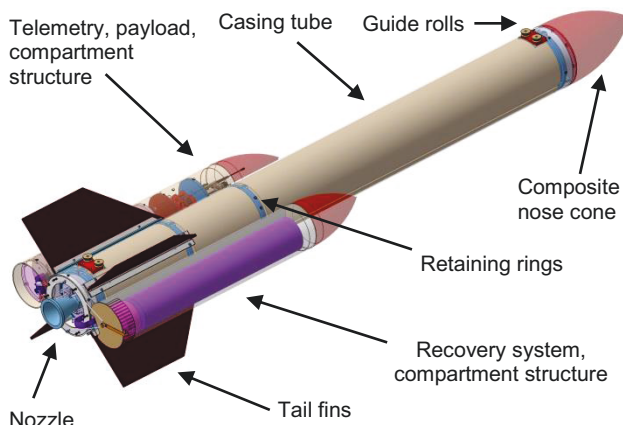

Figure 3 Current development status of TU-Berlin's DECAN's lower stage.

Calculations of the trajectory using ASTOS (AeroSpace Trajectory Optimization Software) predict a peak altitude of 790 m if only the lower stage is launched. The maximum speed will be approximately 87 m/s (0.26 Mach) at a maximum load factor of 4.6 g. According to the design of the fins, the flight stability was determined to be at 1.7 at 0.26 Mach. The following table shows the main parameters of the lower stage.

Parameter	Lower Stage
Rocket type	Hot water propulsion
Motor manufacturer	TU Berlin
Propellant	Water (29 liters)
Scientific payload	Telemetry system, positioning and locating system, cameras, heat and altitude measuring
Nominal diameter	ca. 0.2 m
Length	ca. 2.4 m
Dry Mass	64 kg
Maximum thrust	3 kN
Burning time	3 s
Maximum acceleration	4.6 g
Apogee altitude	790 m (single-staged)
Minimum stability margin	1.7 (@ 0.26 Mach)

TAB 1. Technical Data Sheet of the lower stage

4. UPPER STAGE

The upper stage is equipped with a solid propellant rocket motor which is mounted between two structural rings inside the outer aluminum alloy shell tube. Four fins are spread circumferentially at the tail section of the rocket to ensure an aerodynamically stabilized ballistic flight trajectory. A recovery system is responsible for the safe return and recovery as part of the STERN requirements.

This system is controlled by the integrated electronic system, which has to comply with the ESRANGE Safety Manual [1] as well. Below, Figure 4 illustrates the cross section of the rocket and depicts its particular sub-systems on a detailed part level.

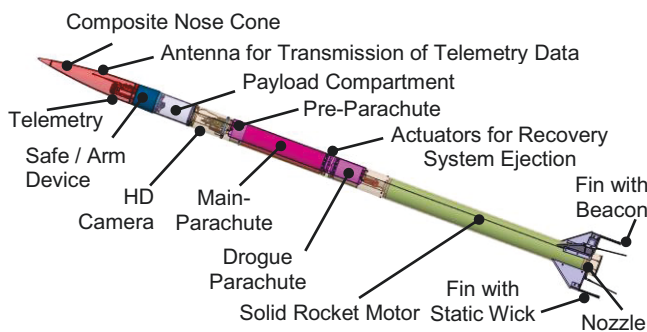

Figure 4 DECAN upper stage rocket and its main components.

The unguided sounding rocket carries a payload to an altitude of up to 6.5 km when launched independently from the lower stage. The payload consists of both a commercial and an in-house developed telemetry system.

Parameter	Upper Stage
Rocket type	Solid propellant
Scientific payload	Telemetry system, video camera
Nominal diameter	ca. 0.1 m
Length	ca. 2.9 m
Dry Mass	23 kg
Maximum thrust	3 kN
Burning time	7 sec
Maximum acceleration	14 g
Predicted apogee	6.5 km
Minimum stability margin	2.1 cal (@ 2.1 Mach)

TAB 2. Upper Stage Technical Data Sheet

Preliminary tests of the DECAN-X rocket have shown high survivability of the attached fins, even in an event of a malfunction within the recovery system. Hence, beacons for ranging have been installed within the Fins.

4.1. Test results

The high power solid rocket motor has been selected to power the DECAN rocket and has been qualified for integration and flight readiness. Independent tests have been performed at a DLR site in Trauen to verify that the mission and test requirements will be met. The tests depict stable engine combustion with an average thrust time of 7 seconds. The maximum measured thrust is reached after 1.4 seconds.

To ensure the functionality of the telemetry under real time circumstances, a compulsory flight test for verification was necessary. Therefore, the Technische Universität Berlin used a small experimental test rocket of the DECAN

rocket family, named DECAN-X. All data have been successfully saved and sent to ground. The pyro events (recovery system) have been triggered according to plan.

The recovery system will be triggered by the rocket's telemetry system. At apogee, the drogue parachute will be ejected in order to provide a controlled descent of the stage to an altitude of 500 m. At this altitude, the main igniter will initiate the pyro-actuator for a deployment of the main parachute. The main recovery system of the rocket consists of a main parachute and an auxiliary parachute. The auxiliary parachute is connected to the cover of the recovery system with a leash. Once the panel flap is unlocked, it opens through a pre-stressed spring mechanism and pulls the auxiliary parachute out of its chamber. The auxiliary parachute pulls the main parachute, which is connected with a leash and a shackle to the upper motor closure. The recovery system has been successfully tested under laboratory conditions. Wind tunnel tests could not be performed.

The air path speed limit for the drogue parachute at an altitude of 6,000 m has been estimated with 356 m/s. The air path speed limit for the auxiliary and the main parachute at an altitude of 500 m has been estimated with 125 m/s and 67 m/s respectively. These speeds must not be exceeded in order to prevent parachute disintegration. The trajectory of the upper stage is plotted in Figure 5. At the time of parachute ejection the air path speed is lower than the calculated limits.

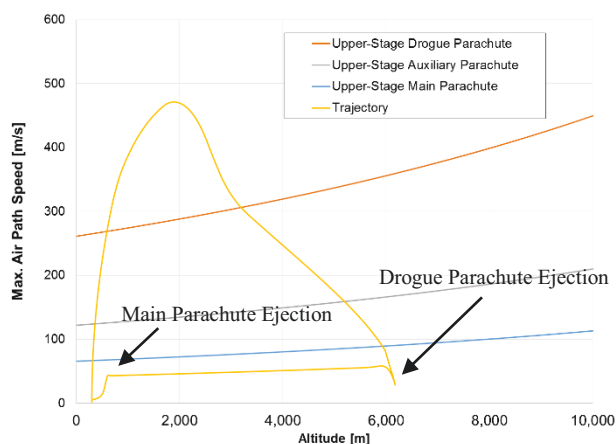

Figure 5 DECAN upper stage rocket and its main components

4.2. ESRANGE Launch

The DECAN upper stage will be launched in a single-staged configuration at the ESRANGE facility near Kiruna (Sweden) in mid-October within the STERN launch campaign. During the campaign, it is intended to launch the EQM and the FM of the upper stage. Both models are fully identical. The EQM will be a build using the EM. The FM will be built shortly before launch. This approach ensures that at least one rocket is launched to avoid a failure of the launch campaign if a rocket is damaged during transport. Hence, the EQM is based on the EM. At

the ESRANGE facility, the Medium Range Launcher (MRL) was selected. The MRL is stored in a protective house with a removable roof. The MRL was chosen because the solid fuel motor is not qualified for temperatures below 0°C.

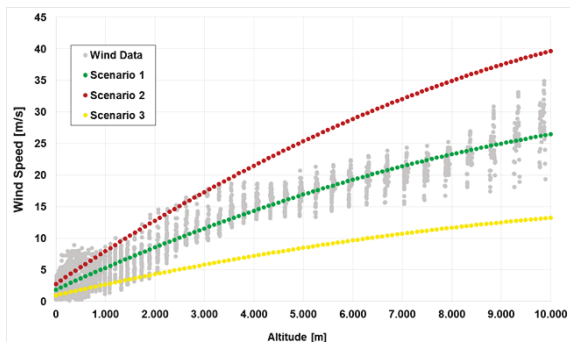

Figure 6 Wind Scenarios 1-3 displayed in wind speed above the altitude

The flight path was simulated using the software ASTOS Release 7.1. The mean wind conditions (Scenario 1) for the launch site Kiruna were provided by the Swedish Meteorological Service (SMHI). To estimate the flight path for lower and high wind conditions, the calculation was also done using 150% (Scenario 2) and 50% (Scenario 3) of the provided wind velocity as shown in Figure 6. The calculation was done for wind directions from 0° to 340° with 20° steps.

TAB 3 displays the critical flight events. The drogue parachute will be ejected shortly after the apogee is reached to reduce the shock caused by the opening of the parachute. The drogue chute will assure a constant sinking rate. 500 meter before impact, the main parachute will be ejected. The main parachute will reduce the sink velocity to less than 5 m/s to ensure minimum damage during the impact.

Event ID	Flight Time [sec]	Description
01	0.3	Rocket leaves the rail
02	2.8	Mach 1.0
03	5.3	Max. Dynamic Pressure
04	31	Apogee
04	32	Drogue Parachute Ejection
05	147	Main Parachute Ejection
06	178	Landing on Ground

TAB 3. Upper Stage Technical Data Sheet

The main performance data are summarized in the table below.

Parameter	Value	Unit
Apogee	6.5	km
Time to Apogee	31	sec
Total Flight Time	180	sec
Max. Mach Number	1.4	-

Parameter	Value	Unit
Max. Flight-Path Velocity	472	m/s
Max. Load factor (G-Load)	14.3	-
Max. Dynamic Pressure	112	kPa

TAB 4. Upper Stage Technical Data Sheet

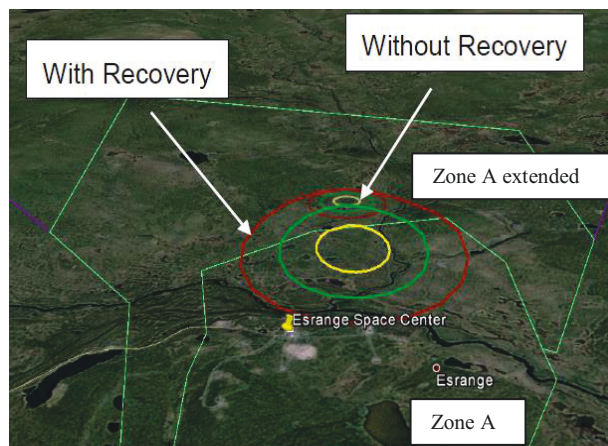

Figure 7 Estimated landing zones of the upper stage

The landing area at the ESRANGE facility is structured in 4 zones. As the zones B and C would have to be evacuated, the DECAN rocket has to land within zone A and zone A extended, shown in Figure 7. The DECAN upper stage will land within zone A or zone A extended considering all defined scenarios. The impact areas are shown for each wind velocity in the figure below.

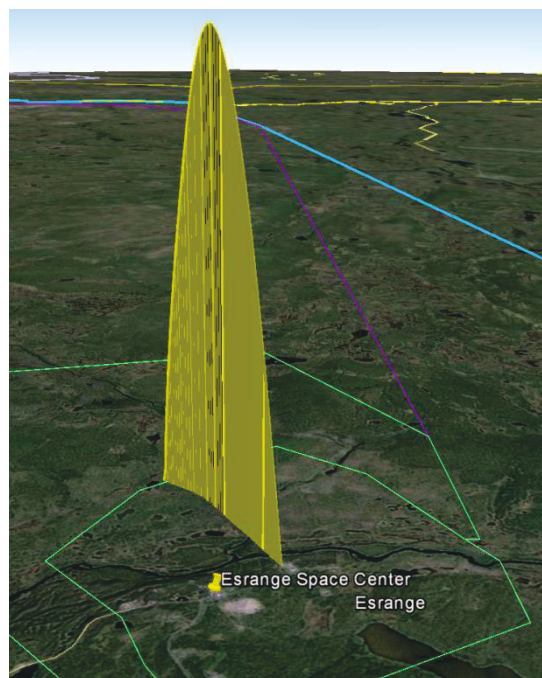

Figure 8 Upper flight path displayed in Google Earth for a low wind velocity from the south

5. SAFE AND ARM DEVICE

One of the novelties during the last months of development of DECAN was the design of the new Safe and Arm Device (S&A). This device has been designed by the authors of this document. The S&A is intended to be flown with both the upper and the lower stages. The first task of the S&A is interruption of the flow of current between the electronics and the power supplies during the launch preparations. The second task is to short circuit the Electrical Explosive Devices (EED's). If both tasks are fulfilled, the rocket is in SAFE mode. That means no subsystem of the rocket can cause any injury to personnel or damage to property. It ensures the safety during the assembly phase at the launch pad. The unlocking or arming of the rocket only takes place when the rocket assembly is completed and all team members and other people have left the danger zones. Switching to the armed mode happens in two single steps. First of all, the power supply is connected to the electronics. If this is successful (telemetry reports a valid GPS position), the second step will be initiated. This step connects the EED's with the electronics. The splitting is necessary to avoid an uncontrolled ignition of the rocket motor by the on-board electronics in the event of a failure within the electronics.

After the activation of the S&A, it is not allowed to enter the danger zones (around the launch pad) because the rocket is in armed mode and thus ready for launch. In case of a necessary access to the danger zone (e.g. if the launch was not successful), the S&A has to deactivate the electronics and short the EED's. At this point, it is safe to approach the rocket to look for possible issues. This will allow readying the rocket launch again and the procedure will be started anew. The S&A is operated from the user's blockhouse (ESRANGE), outside the danger zones.

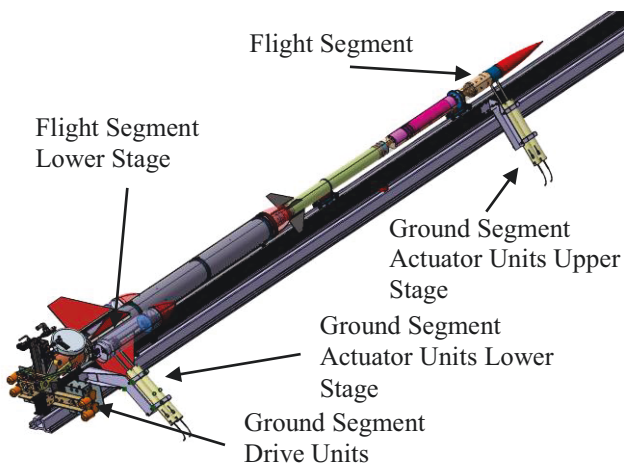

Figure 9 Safe and Arm Device attached to the rocket.

The S&A consists of two main segments. These are: the flight segment and the ground segment, the latter is composed of the actuator and the drive unit. The flight segment (FS) is incorporated in the DECAN rocket, both in the first and in the second stage. The FS consists of two individual S&A devices, one of which controls the electronics, telemetry system and also the payload, e.g. CanSat compartment. The second S&A device is in charge of arming / disarming the pyrotechnics system (EED). These two modules can be activated individually by their respective counterpart (the actuator), which is located on the ground segment. The actuator unit is enabled by the drive unit, using a Bowden cable. Figure 9

shows the main components integrated into the rocket and ground segment.

5.1. Flight Segment

The system is capable of arming and disarming the system on command. It also guarantees the system's safety in the case of an electrical failure or total power loss. The system's first draft consisted of an actuator (or several actuators) and micro switches. The device's purpose is to activate a stack of micro switches. These components control different tasks within the rocket, such as the electronics and telemetry segments and the pyrotechnics.

The first concept for the flight segment (shown in Figure 10) consists of an actuator shaft with a double taper and two actuators, one on each side of the shaft. The actuators are the components in charge of activating the micro switch stacks. The actuators were positioned in such a way as to be pressed out and push onto the micro switches when the shaft was pressed in by the ground segment's actuator shaft. The movement of the actuators was caused by the pressure applied by the shaft's forward movement via the tapers. A more detailed functional principle will be shown later in Figure 11. The idea behind the concept for the flight segment was kept and elaborated further. The current and final design of the flight segment will be shown its respective section.

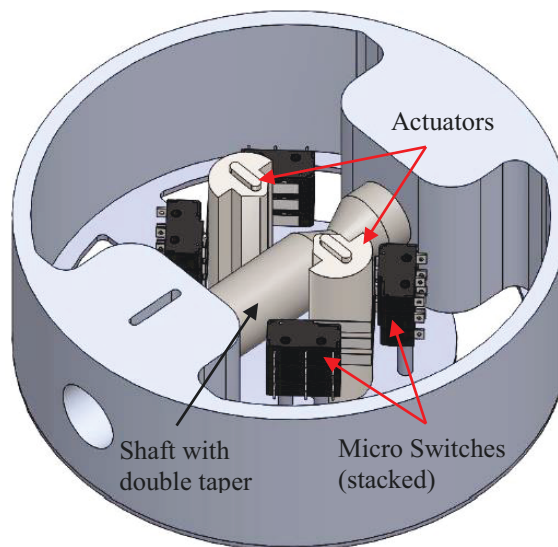

Figure 10 First concept of the Safe & Arm device

During the concept phase of the project, different methods of activating the S&A device's actuator shaft were looked at. This main actuator is part of the ground segment and is in charge of activating / deactivating the flight segment's safe and arm device. The third and last concept, which was also the concept that was agreed upon, consists of an actuator shaft that is pulled by a Bowden cable. This cable is reeled in on a shaft that is driven by an electromotor. This concept allows for a large stroke length (>150 mm).

The DECAN rocket will be equipped with two safe and arm devices per stage, i.e. two S&A for the first stage and two S&A for the upper stage. Each set of two S&A will be referred to as flight segment (FS). The flight segment of the upper stage is located on the upper part of the rocket, as show on Figure 9. The first stage's FS will be located in the electronics compartment.

The following image depicts one of the flight segment's S&A without its exterior cover in order to provide a better insight of the inner components. The components have been colored in order to provide a better visualization. The image shows the casing (transparent grey), the actuators (green), and the actuator shaft with taper (orange), the resetting spring in the back (red), the stroke limiting pin (blue) and the micro switches (black). The actuator springs (thin springs) are also shown in red. The device is shown in SAFE MODE.

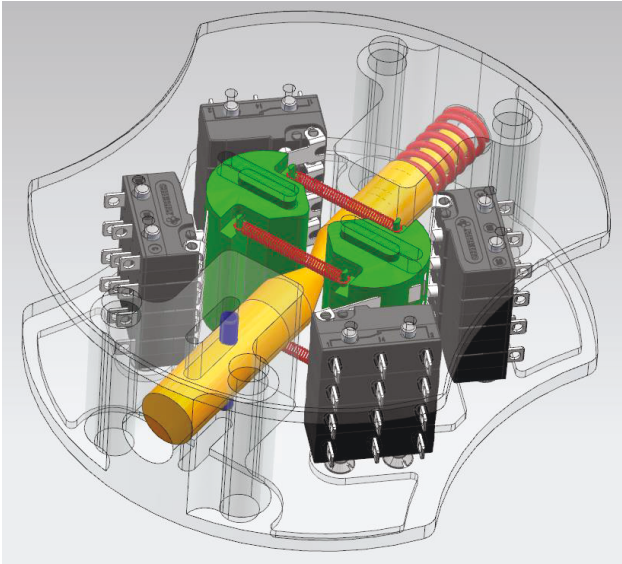

Figure 11 Flight Segment - final concept

The functionality will be explained with the use of schematics in order to make it easy for the reader to notice the differences, seen in Figure 12.

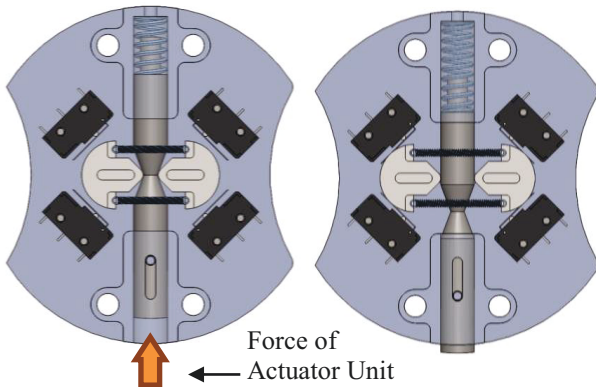

Figure 12 Left: SAFE MODE; Right: ARMED Mode

Pressing the flight segment's tapered shaft causes the actuators to be displaced sideways. These components release the micro switches, placing the rocket into SAFE MODE. To switch back to the ARMED MODE, it is only necessary to release the pressure on the tapered shaft. The latterly mentioned mode is also the mode the S&A remains in during flight. In the ARMED MODE, the resetting spring keeps the tapered shaft in the starting position. Therefore, the actuators are in the displaced position and keep a constant pressure on the micro switches. This should prevent any unwanted switching of the micro switches during flight.

5.2. Ground Segment

The ground segment is no part of the actual rocket and can be used numerous times. Consisting of an Actuator and a Drive Unit the main function of the Ground Segment is to activate the Flight Unit.

5.2.1. Actuator Unit

The actuator unit of the ground segment encompasses the actuator shaft, its casing, a tensional spring, and an electromagnet to hold the actuator shaft in position away from the rocket's flight path. This assembly has a built-in micro switch that will be activated when the actuator is locked on to the electromagnet. Its function is to shut down the electromotor after the maximum stroke length is reached, i.e. when the iron disc at the back of the actuator shaft snaps onto the electromagnet. The following image shows the CAD model of this component in the extended position, consisting of the following parts: The actuator spring (red), the actuator shaft (orange), the electromagnet (green), the Bowden cable (blue), the housing (grey components), an iron disc (brown), located on the back side of the actuator shaft and the micro switch (black).

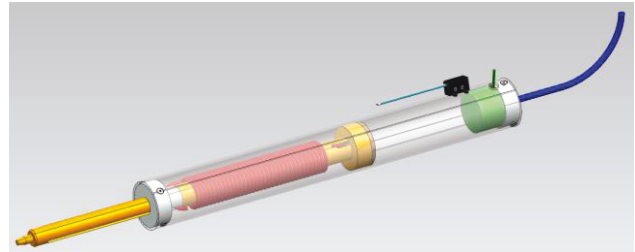

Figure 13 Ground Segment (Actuator Unit)

The electromagnet has been modified in agreement with the manufacturer to allow its use in this device. It has been retrofitted with a 3 mm concentric bore-hole to allow the assembly of the Bowden cable.

5.2.2. Drive Unit

Each drive unit consists of an electromotor with a worm gear. This electromotor is connected to an electromagnetic coupling. This device couples the motor's drive shaft with the shaft that is used to reel in the Bowden cable.

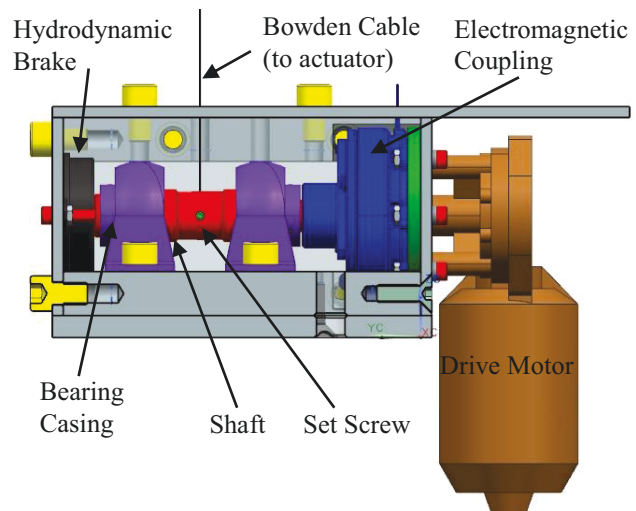

Figure 14 Ground Segment (Drive Unit)

The cable is kept in place inside the shaft by a set screw. The shaft is held in place by two bearings. A hydrodynamic brake is connected to the free end of the shaft. This brake slows down the rotation of the shaft only in the direction opposite to the rotation of the motor, i.e. the unroll direction. The functioning of the system will be described in subsection 5.3. Each flight segment S&A requires one actuator (see previous section) and one drive unit. For simplicity reasons (manufacturing), each drive unit casing contains two drive units. Figure 14 shows a cross-section of the drive unit.

Each of these units consists of following components: The drive motor (brown), the casing itself (transparent grey), the shaft (red), the electromagnetic coupling (blue), the bearing casings (purple), and the hydrodynamic brake (black). The set screw to hold the Bowden cable inside the shaft is marked in green.

5.3. Modus Operandi

The following paragraphs will describe the *modus operandi* of the safe and arm device. Figure 12 shows a cross-section of the flight segment. This image includes the forces applied by the actuator shaft. The image shows the safe and arm device in its disarmed (safe) state on the left side and the armed state on the right side. The orange arrow represents the force applied to the shaft of the flight segment by the actuator shaft of the ground segment.

The actuators are positioned on the flight segment's shaft and have activated the micro switches (see Figure 12, right). The system is armed. The armed position of the actuators has been chosen to be the one depicted on the image (i.e. held by the shaft and applying constant pressure on the micro switches) to guarantee that the actuators will remain in the right position during the flight of the rocket, which will prevent the circuitry to be deactivated accidentally.

Bringing the rocket back to safe mode shall occur under the following circumstances: The first circumstance is a manual (deliberate) disarmament of the rocket. In this case, the user presses a button to disarm the system. The second condition in which the rocket will be disarmed will occur under the following assumption: Should a problem with the electrical supply to the rocket's system arise, for example a total power loss at the launch site or any similar events, it is the task of the S&A device to disarm the rocket to prevent an undesired mishap. For this reason, the system was designed to disarm the rocket in the event of power loss. Regardless of the circumstance, the S&A device will disarm the same way. The following steps will describe the mechanics of the system, starting from the armed state, e.g. the rocket is on the launch pad and has launch clearance.

- 1) The electromagnetic coupling between the drive shaft of the electromotor and the shaft that reels in the Bowden cable will lose power. This leads to a decoupling of the two shafts. At the same time, the electromagnet in the actuator unit will lose power. The spring on the ground segment will pull off the Bowden cable, which will start to unroll from the shaft. This will cause the actuator shaft to move forward towards the rocket. This movement is slowed down by a hydrodynamic brake in order to keep the actuator shaft from hitting the rocket at a high speed. After a certain stroke length, the actuator shaft will have

reached the double tapered shaft of the flight segment and will apply a pressure on it.

- 2) The actuator shaft of the ground segment (Figure 13) will continue to apply the force and push the flight segment's shaft until the actuator shaft reaches its mechanical stop in the ground segment's casing. It is intuitive that the force applied by the ground segment's actuator shaft has to be larger than the force from the resetting spring. The result of this is the forward moving of the flight segment and the compression of the resetting spring.
- 3) The forward moving of the flight segment's shaft allows the actuator springs to move the actuators into the safe position, i.e. touching the narrowest cross-section of the double tapered shaft, see Figure 12 (left). At this point, the actuators no longer have contact with the micro switches and therefore the circuits are interrupted, bringing the rocket back to the safe mode. To go back to the armed state, electrical power is required. To arm the rocket, the electromagnetic coupling will engage again and the electromotor will start turning, reeling in the Bowden cable and pulling the actuator shaft back and away from the rocket. The electromagnet inside of the actuator unit secures the actuator shaft in position and the electromotor of the drive unit will be shut down. The resetting spring will push the double tapered shaft back to its original state and the rocket will be armed and ready to launch.

5.4. Control Panel

The primary function of the control panel is to operate the ground segment drive unit of the S&A. The drive unit consists of two electric motors with two electromagnetic couplings. The electromagnetic coupling couples the drive shaft of the electromotor and the shaft that reels in the Bowden cable.

Both redundant parts of the drive unit (each one consisting of: an electromagnet, an engine protection, a DC engine, an electromagnet coupler, a switching delay) are electrically fed through two separated main circuits. Each of these circuits can be closed through a respective relay. The relays are supplied and operated through two parallel control circuits which can be opened/closed by mechanical switches. The distance between the control panel switches and the drive unit can vary in the range of several hundred meters. This can lead to unpredictable voltage losses.

Due to this approach, the mechanical switches on the control panel and the main circuits are electrically decoupled which offers the advantage of bypassing possible voltage losses.

The control panel also consists of an auxiliary circuit, which provides a visual interface for the user. This particular circuit is supplied by a 5 V DC adapter, furthermore it is comprised of 2 red LEDs and 2 green LEDs with respective multipliers. Each LED can be switched on/off through a respective relay.

Both main circuits are supplied by a 24 V DC adapter. The electrical parts of the drive unit were chosen in order to fulfill the requirement of a 24 V DC nominal voltage. Due to the different amperage, the electrical parts (magnet, motor and coupling) are connected in parallel order.

Each electromagnet and the respective green LED are the first elements in each main circuit which means they

remain switched on at all times. When the shaft of the actuator unit reaches its final position, it activates a built-in micro-switch which disconnects the motor and the coupling from the power supply unit after one second (switching delay). The switching delay is used to ensure that the final position is reached. Simultaneously a relay of a respective red LED is powered and the actuator shaft snaps on the electromagnet which is now held by the magnetic force only. With the help of the green and red LEDs on the visual interface it can be identified which of the two main circuits is powered at a time and which actuator reached its final position. In the event that the micro-switch fails or if the engine load exceeds the normal range, an engine protection for each engine is used.

5.5. Test results

All parts have been manufactured and tested by the DECAN team. The system has proved to be reliable within laboratory conditions. All requirements have been met. In case of a power failure, the rocket is set to safe mode.

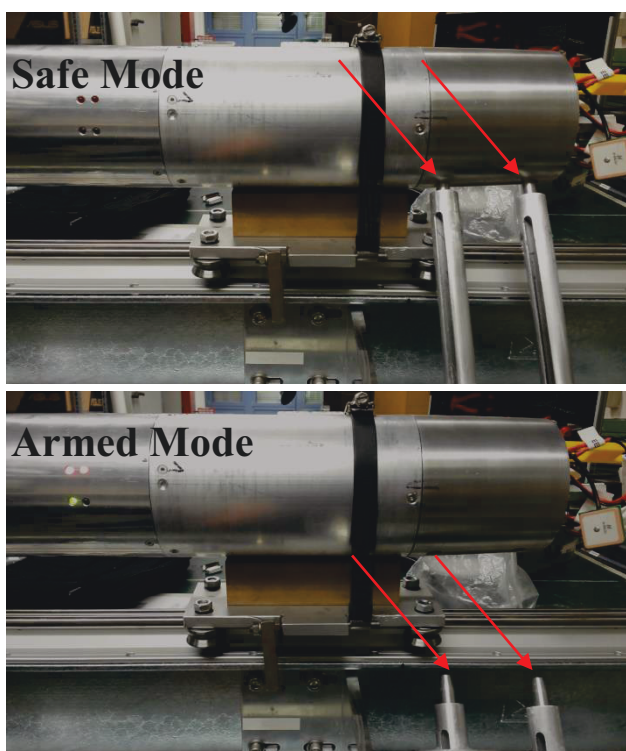

Figure 15 Test of the S&A Device

An image of both, safe and armed mode is shown in Figure 15. The right actuator activates the EEDs displayed by two red LEDs, while the left actuator enables the telemetry and the beacons. The beacons have not been installed during this test. Therefore, the right green LED is not shining.

6. CONCLUSIONS

This work describes the current development of the DECAN rocket at the Technische Universität Berlin. The different components of the rocket were explained in detail. Safety features such as the newly developed Safe and Arm device were shown. Future work shall be focused on further qualification of components such as the Safe and Arm Device. Test flights are scheduled for the next months and have been coordinated with the DLR.

7. ACKNOWLEDGEMENTS

The authors would like to thank Dr. Harry Adirim and Michael Schmid as well as the DLR MORABA team for their support. This work was funded by the DLR's STERN project.

Bibliography

[1] **Widell, Ola:** *Esrangle Safety Manual*. Kiruna : Swedish Space Corporation, 2014. REA00-E60.



Gefördert durch:



Bundesministerium für Wirtschaft und Technologie

aufgrund eines Beschlusses des Deutschen Bundestages

FKZ: 50 RL 1251



Deutsches Zentrum für Luft- und Raumfahrt German Aerospace Center

