

SUPEREFFICIENT QUIET SHORT RANGE AIRCRAFT

M. C. Schwarze, Stuttgart, DE
T. Zold, London, UK
renew.innovation@email.de

Abstract

In the scope of this technical paper a novel aircraft configuration for a superefficient aircraft is developed within an integrated approach and conceptually be built on an existing short range aircraft. The "Inliner", a novel standard short range aircraft, is mainly characterized by a unique architecture, consisting of a set of two counter-rotating open-fans positioned in-line and thereby encircling the fuselage at a longitudinal fuselage station in front of the wings.

Remarkably improved fuel efficiency of the Inliner is first achieved by a significantly increased propulsive efficiency (as a result of its special Open Fan-engine architecture), second by its improved thermodynamic efficiency (as a result of special recuperative technical measures on the two driving turboprop-engines) as well as third by its improved aerodynamic efficiency (resulting from the omission of engine pylons and nacelles, from boundary layer ingestion, from pressure recovery and from a clean wing with optional laminar flow concept). The combined measures of this integrated approach result in a significantly improved efficiency and realistic fuel savings of 40-45 % on a standard short range mission of 700 nm.

At the same time with this innovative propulsion architecture according to first calculations the outward perceptible noise could be lowered by around -15 to -23 dB, meaning by - 67 to -75% regarding the outside perceived human noise intensity. The two Open Fans, however they rotate open in the fluid for best efficiency, are completely different from known open rotor configurations in terms of their aerodynamic design and their accompanied noise level. In fact with the Inliner configuration two of the most inherent challenges of former open rotor configurations – noise and rotor burst, respectively blade-off - can be solved. As fuel consumption, respectively CO₂ emissions can be reduced by 40-45%, NO_x levels are up to 23% lower and the outside noise level could be dropped by more than 2/3s, the Inliner is an aircraft configuration, which will tend to comply with the ambitious ACARE Vision 2020 targets.

1 INTRODUCTION

There is a continuously increasing demand both with airlines but also in society as a whole for a very fuel-efficient and environmentally friendly aircraft. Efforts made to reduce fuel consumption and aircraft's emissions are not only relevant for an increased environmental awareness and a general wish for clean and affordable air travel, but also a vital interest of aircraft operators to significantly reduce operational costs especially in terms of fuel burn.

The cost of fuel for today's airlines account for about 30-40% (2014) of the direct operational costs for short range aircraft. Besides a significant reduction in operational cost, fuel savings would theoretically allow for a positive influence enabling a reduction of ticket prices. This could potentially result in an increased mobilisation of people, similar to that resulting from the era of the Low Cost Carriers. This not only boosted the total number of flying passengers, but also significantly increased standard short range aircraft orders of the four main aircraft manufactures. At the same time airports are eager to lower noise emissions, especially of short range aircraft, without reducing the number of take-off and landing cycles and

without disadvantageously restricting the operating times of the airport. Particularly, inhabitants in the vicinity of airports tend to desire lower noise exposure as a mean of improving their health and quality of life. A global trend of

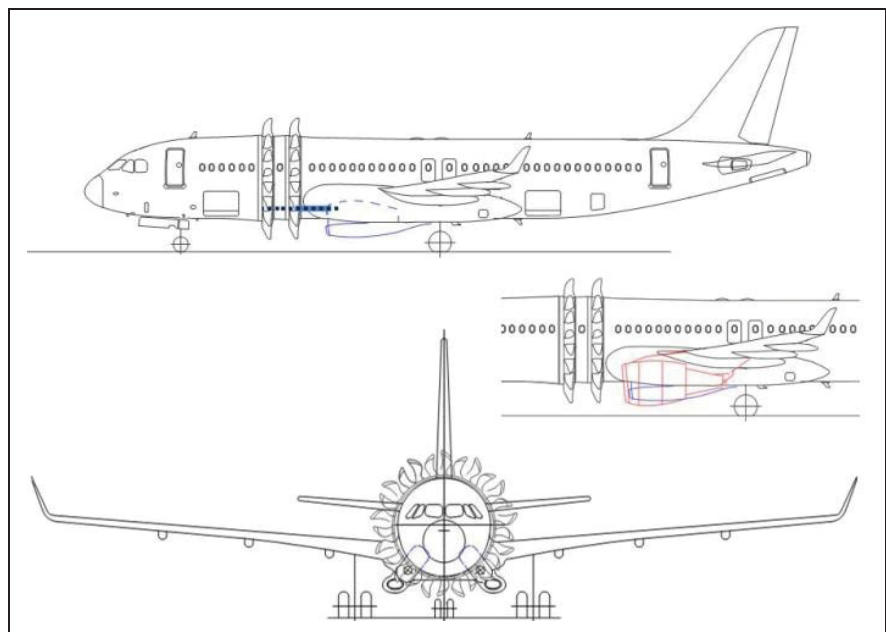

FIG 1. Front and side view of the Inliner aircraft configuration with its two counter-rotating Open Fans encircling the fuselage in front of the wings

increasing environmental awareness has led to an effort to reduce the environmental impact of the aviation sector.

This topic has received increasing attention in both national and international politics creating a demand for lower fuel consumption, reduction in noise and emissions and for an overall clean, sustainable and quiet aviation.

The European aviation industry, including the aircraft and engine manufacturers, have reacted towards these social needs by agreeing to commitments intended to lower the environmental footprint of aviation significantly, however only within a considerably lengthened timeframe. The first of the two most important European commitments has been established by the ACARE Vision 2020. This stipulates a reduction of 50% in fuel consumption and CO₂ emissions, a 50% reduction in the outside perceived noise level as well as a significant cut in NO_x emissions by -80% until the year 2020 [3].

The ACARE Vision 2020 was upgraded by Flightpath 2050, which targets a reduction in fuel and CO₂ emissions by -75%, a reduction in NO_x emissions by -90% and a significantly quieter operation by reducing the outside perceived noise levels by -65% [7]. The reference level for benchmarking these reductions in noise, emissions and fuel consumption is the state-of-the-art of technology, represented by aircraft and engines from the year 2000 [3,7].

These commitments are in-line with the economic interests of the aviation sector as profit margins have shown to be severely decreasing due to sustainably rising fuel prices. It should be noted that from the present technological, social and political stance achieving of the goals set out in the Vision 2020 are highly improbable. Considering the characteristically long development cycles in aviation, there are as of today still no suitable technologies, concepts or strategies available today or on the horizon which could independently fulfil the rigorous targets set forth for emissions.

Even the goals of Flightpath 2050 initiative will be challenging considering the current pace of development both technical and political. Aircraft manufactures continue to limit their development to re-engineered versions of their standard short range aircraft designs, which have technical designs based in the 1970s (Boeing 737; 45 years ago) and in the 1980s (Airbus A320; 35 years ago). The improvement in fuel efficiency of these updated versions are however relatively poor in comparison to the potentially available recourses and expertise in the possession of aircraft and engines manufacturers. There is a continuous lack of research on an adequate level with smart and integrated approaches to developing target-orientated technology that can be implemented on future aircraft.

2 PRESENT CHALLENGES FACING A SUPEREFFICIENT AIRCRAFT DESIGN

Why are there no superefficient aircraft flying - or in the final stages of development today despite an intense demand and broad support for such a technology from many interest groups including airlines, airports, politicians and society as a whole? The term superefficient aircraft would in this case refer to any aircraft with a significant decrease in fuel consumption and noise footprint; an aircraft that would enable the reaching of some or all of the target levels set forth in Vision 2020.

A first reason is an embarrassment within the future technology departments of the aircraft and engine manufacturers about the viability of which technology, if any at all, might be sustainably suitable for the upcoming future.

For example, present engine concepts and technologies, including geared turbo-fans and open rotor technology, could potentially yield a fuel reduction on aircraft level of 20% to 25% [1]. With no other major technological advancements in terms of engine development being realised in the near future, this leaves a significant gap to the ambition of a 50% reduction for the ACARE Vision 2020 [1], or for that matter the Flightpath 2050.

Secondly, the concentrated efforts on a single isolated technology or technical measure would not be enough. To comply with Vision 2020 or Flightpath 2050 requirements neither the mounting of winglets on a 35 to 45 year-old aircraft design is enough, nor is it appropriate to install newly bought engines with an increased bypass ratio and a geared turbofan architecture on the aircraft (this single measure leads to fuel savings of around 10% to 12%).

With regards to the geared turbofan architecture it should be pointed out that this not a novel technology. Geared turbofan architecture has been in scheduled operation for more than 32 years on the BAe 146 and Avro, also known as the "Jumbolino", which was/ is regarded as a silent and reliable aircraft. Being flown by the world's largest airlines such as British Airways, Lufthansa, Air France and Swiss the aircraft is being phased out across the airlines. Despite its established historic past the geared-turbo-fan, although in a slightly updated version, is often deceptively portrayed to society as the new innovation to conquer the challenges of the future.

In an effort to achieve the self-imposed commitments of ACARE Vision 2020 and Flightpath 2050 installing new engines (around -10 % fuel savings), retrofitting winglets (around -3 % fuel savings) and doing some slight aerodynamic facelifts e.g. at the bellyfairing (around -1 % fuel savings) is not enough to yield the required results. There is no industry wide trend encouraging radical innovation among aircraft manufacturers and improvements are being done merely to an extent to secure new aircraft orders.

It should be noted that aircraft sales, especially for short range aircraft, are on a record level and earnings of the aircraft manufacturers are solid. In spite of that, the research efforts and spending on a national and international level have been remarkably cut by the European aircraft manufacturers over the last years.

At the same time aircraft manufactures are portraying themselves in the public as highly innovative with appealing designs, such as the concept planes or supersonic configurations. These concepts have nice esthetic value, but are neither adequate to establish a real and sustainable contribution to significant fuel and noise savings in operation on a larger scale, nor are these concepts mature enough to be able to establish themselves on the market on a greater level within a reasonable timeframe. These shown concepts are primarily made for press and public relations.

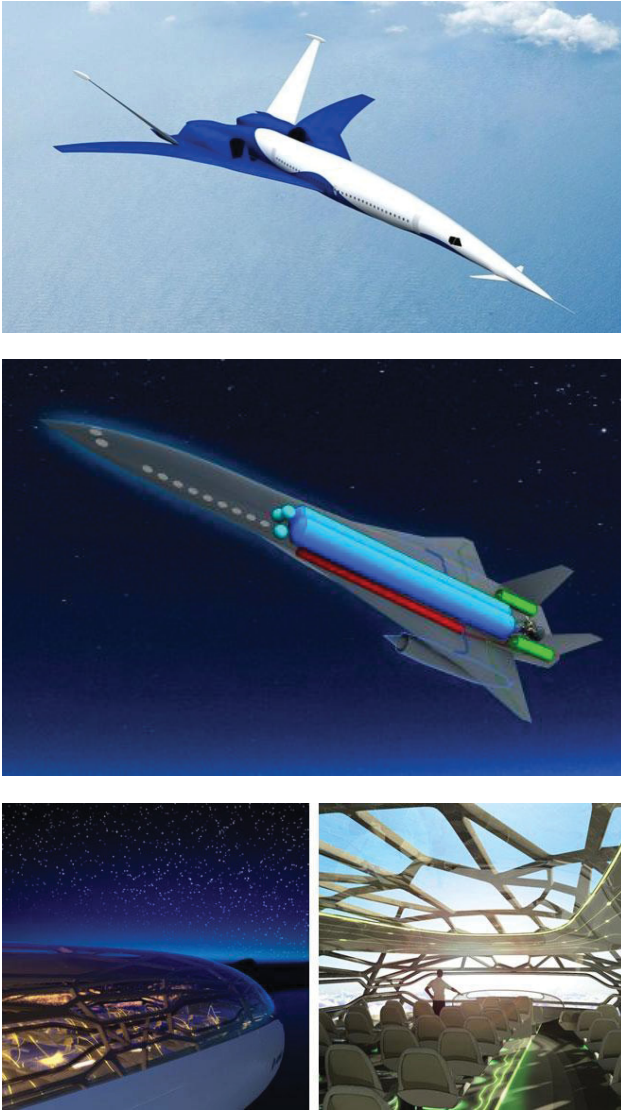

FIG 2. Present supersonic and subsonic concepts of the aircraft manufacturer appear eye-catching but often do not provide realistic future mid-term solutions for cutting down fuel consumption, noise and emissions realistically [29,30,31]

The current politics of the aircraft manufacturers tend to appear as if their designs are primarily to satisfy visions of stakeholders and not customers, passengers and especially not global society. This one-sided strategy does not comply with actual social and global needs and the demand for a sustainable efficient and quiet aircraft. At the same time it is not bringing the manufacturers closer to achieving their self-imposed commitments, nor are they fulfilling the ecologic and environmental responsibilities that all multinational transport companies, especially in the western world, should strive towards.

Current airliners are reaching a limit where each incremental improvement through optimization requires significantly larger effort than the previous one. This will make innovation increasingly difficult as long as no radical changes are made in the concept.

The nearly stubborn persistence to the conventional aircraft design allows only for innovation to be done "in a linear way" focusing on solving detailed "problems" rather

than finding a global solution with an integrated, systematic and holistic approach on an aircraft level. Merely utilizing such a one dimensional approach for this ambitious goal of significant fuel and noise emissions reduction is not enough. There is a need for a multidisciplinary approach, which is well suited to combine and cross-link existing and future disciplines of aircraft design, e.g. aerodynamics, structure, design, engines, weight etc. but also other technical fields, like e-mobility, as well as creative factor. Besides the usual thorough analysis, this new approach should also include a synthesis.

By combining different perspectives in the problem finding process, one single and integrated solution can be found. The creative element is one of the key parts of this integrated solution process. It can either come from a single individual or be developed in a team. In the aviation sector, working in an international team with many different national interest involved, caution has to be taken not to lose value by trying to satisfy all participants and thereby hinder radical innovation.

The creativity element should also not be left to be done by computers. Their capabilities are limited to only reproducing and executing what has initially been programmed into them by humans. To date there is no way of technically or artificially creating creativity, as creativity requires awareness, which can be only found in the human mind to various extents. Awareness cannot be generated with computers in the same and adequate manner. The creativity, which seems to be a result of computers and computer programs, is only the result and a reflection of the human creativity that was previously invested in this process. Computers can merely realign facts, but they cannot and will not generate new ideas. Computers and computer programs should only support these creative ideas and help to get a detailed design and optimization of an existing idea, once these ideas have been developed. But these ideas have to be discovered by creative humans before.

For an integrated approach in creating a superefficient aircraft, there have to be individuals, who have developed a specific capability of integrative and cross-linked thinking, and who are trained and willing to contribute their creativity in the design process on a high level. The right people for this task normally are not specialists but generalists who are able to talk to specialists. They bring solid knowledge about different technical fields in aircraft design and in one or more fields of knowledge beyond that. Furthermore, they are familiar with different methods of problem solving and are able to creatively developed new ones, with an integrated view on a problem. Experience shows that these individuals more often than not are not the ones with the best grades or those who have perfectly assimilated to the academic or research community.

It has been shown in studies that Nobel Prize winners often are often familiar in at least two different disciplines e.g. in biology and physics. Their creativity is developed or expressed by combining these two or more different disciplines and their specific way of thinking. Furthermore, they often show a non-assimilated behavior and an own characteristic way of thinking.

From a human resources perspective it is also important that these creative individuals are not only incentivized by the usual wage and any additional perks such as cell phone, company car, etc. but also non-materialistic incentives such as providing the right working conditions. Crea-

tivity can best be harnessed in a non-pressured environment. This would generally constitute no or very little hierarchy, freedom of thinking, an environment in which the employees feel trusted by their superiors, very flexible working times and the freedom to work where they want and with whomever they want. People who are creative are aware and sensitive to their working environment and working conditions and overall working atmosphere. There are in existence today a few market leading companies that have identified the importance of creating an environment that fosters innovation, e.g. Google, Apple and many companies in the advertising, design and software industry.

Such an innovation incentivizing trend to attract and keep the right specialists with integrated thinking capabilities cannot be found in the aviation industry, especially not among aircraft and engine manufacturers. This would however be a key requirement to enable innovations such as a superefficient aircraft. By attracting suitable individuals, who contribute with their knowledge to a "non-linear", creative and integrated approach in creating a smart aircraft design, a design could be achieved that would guarantee sustainability and social acceptance as well as future economic success - not only temporarily, but lasting.

3 A NEW WAY OF THINKING AND DESIGNING

For establishing a new integrated approach for a superefficient short range aircraft, a deeper analysis on how an aircraft can be made fuel efficient has to be undertaken before.

3.1 Improving an Aircraft's fuel-efficiency

In general there are four known ways, for making aircraft more efficient. These four known ways are:

- I.) Enhancement of the aerodynamic efficiency. Above all keeping the wetted area of the aircraft to a minimum for a low zero-lift drag and decreasing induced and interference drag.
- II.) Enhancement of propulsive efficiency, in other words the efficiency in which onboard energy is converted into thrust and propulsion of the aircraft. This is however a complex issue that often requires the simultaneous implementation of several different approaches and measures.
- III.) Enhancement of the thermodynamic efficiency of the engines. In aircraft engines power is produced through a thermodynamic process, by enhancing this process to minimize losses the overall efficiency of the engines can be boosted.
- IV.) Reduction of weight. The overall weight of the aircraft influences the induced drag, which is a major portion of the total drag. By keeping the total drag at a minimum the necessary thrust required can also be reduced. The less thrust is needed the less fuel is consumed.

In designing a super-efficient aircraft an efficient and effective combination of the above mentioned has to be found.

4. INLINER - AN INTEGRATED APPROACH TOWARDS A SUPEREFFICIENT AIRCRAFT

4.1 Inliner- Enhancement of the aerodynamic efficiency

In enhancing the aerodynamic efficiency of an aircraft the most important measure is to keep the wetted area to a minimum and thereby also lowering the zero-lift drag of the aircraft. With the Inliner this is done by the omission of nacelles and pylons, which characterize the unique architecture of this aircraft. Especially the nacelles, which are exposed to fluid both on the inside and outside, generally have a significant contribution to the wetted area of the aircraft (*pylons wetted area 2x5.2m² nacelles: 2x43.9 m² => by omitting both pylons and nacelles: - 98.2 m²*. Comparison: the reference geometric wing area of the Airbus A320 is 122.6m², the area of the vertical tail is 21.5 m² and the area of the horizontal tail is 31 m² and the total wetted area of the empennage is around 105 m²).

Reductions of induced drag can be achieved through the fitting of winglets as well as through aerodynamic facelifts, such as the reshaping of the bellyfairing, as it is at least partly exposed to the propeller-streams of the Open Fans. Additional methods with less significant effect on the overall drag level include an optimized design of air inlets e.g. for air conditioning and fuel venting, an overall enhancement of the skin quality and the sealing of gaps in the rudder.

Enhancement of aerodynamic efficiency	Reduction in mission fuel [source]	
Omission of pylons and nacelles	5.8% [26]	
Outer Wings: Installation of a Natural Laminar Flow concept on clean wings	3.0% [26]	(potential up to 10-12%) [1]
Installation of winglets and reshaping of the bellyfairing	3.0% [26]	
	1.0% [26]	
Pressure recovery by a diffuser encircling the fuselage downstream of the fans/ by the contraction of the fuselage itself	4.1% total effectiveness still uncertain at this point	
Boundary Layer ingestion BLI at the rotors at their specific longitudinal fuselage station	5.0% [33]	
Total	21.9%	

FIG 3. Fuel savings achieved by specific measures enhancing the aerodynamic efficiency of the aircraft

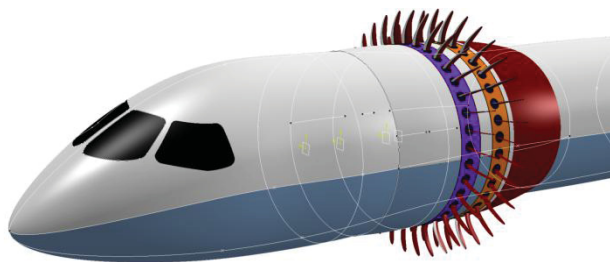

FIG 4. A diffuser (here marked in red) can be arranged downstream the fan system, encircling the fuselage, to convert the additional speed, passed by the rotors to the fluid, into pressure (pressure recovery) and thus partly in additional thrust for the aircraft. The pressure recovery can also come from the fuselage overall geometry in general, more specifically from the contraction of the aft fuselage.

4.2 Inliner-Enhancement of the Propulsive efficiency



FIG 5.above.Fan-tip speed, ground clearance of engines and drag-effective wetted area of enlarged nacelles becomes a performance and safety issue with increasing by pass ratio thus fan diameter of the engine

FIG 6. At the Boeing 737 the installation of the engines below the wings already at the older models required advanced, adopted pylon- and nacelle design



With the Inliner configuration the propulsive efficiency is improved by a combination of measures. To better understand them and the associated integrated approach in which the propulsive efficiency is enhanced, a closer look has to be taken at the existing and future challenges of current turbofan-engines.

4.2.1 Challenges and limitation of present and upcoming turbofan-engines

It is known that an increase in the bypass-ratio of the turbofan will enhance its propulsive efficiency.

In general, there are two different methods of thrust generation. The first is accelerating the fluid in the engine to a very high speed through the nozzle. In this case thrust generation is mainly the result of speed. Due to the high velocity of the air a relatively small thrust area is sufficient. This type of thrust generation is mainly suitable for fast flying aircraft, such as fighter jets. Due to the high velocity of the air exiting the engine they tend to be very noisy.

The second method works with an increased mass flow rate to generate the required thrust. There is a lower increase in the speed of fluid through the engine, however on a much greater thrust area. This type of thrust generation is relatively quiet as the additional speed increase of the fluid is relatively low. It is also very efficient for low and moderate flight speeds of up to Ma 0.9. It is for these reasons the most widely used method for thrust generation in transport aircraft, because it combines high efficiency with low noise emissions.

In general, the specific thrust is defined as the thrust generated, divided by the mass flow rate of air. As the specific thrust of this kind of engine is very low (because of the high mass flow ratio of air), the area for thrust generation, more specifically the geometric rotor area of the fan, has to be significantly enlarged in order to be able to reach the desired overall thrust level.

In conventional turbofan engines efforts have been made over years to further enhance their propulsive efficiency, especially by increasing the by-pass ratio, which in turn leads to a reduction in fuel consumption. Values for the highest obtainable by-pass ratios for modern future turbofan engines are in the range of up to 13:1 to 15:1.

It would be difficult to further raise the by-pass ratio beyond these values due to several specific physical limitations. With growing by-pass ratio the mass flow ratio through the fan, which generates most of the thrust, is significantly increased, leading to a low specific thrust. In order to reach the desired and necessary thrust level for propelling the aircraft the geometric fan area has to be increased significantly. A larger fan area requires a larger diameter of the fan and hence a nacelle and a complete engine with greater dimensions.

With an increasing overall diameter and size of the engine on the one hand the engine gets heavier itself and on the other hand it becomes more and more difficult to install them on the aircraft. A good example of this geometric constraint can be seen on the Boeing 737 and the development of its version, the Boeing 737 MAX. As on most of the airliners the engines are mounted on pylons below the wing and even when taking into account a "gull wing

design”, it is difficult to maintain a proper ground clearance. As a consequence, if larger engines are to be installed the landing gear has to be lengthened which results in large amounts of additional weight and thus extra fuel consumption. The greater the engine gets in dimension the more weight is needed for the engine, its installation and the enlarged landing gear. This would in turn not only tend to counter act any reduction in fuel consumption from the increased by-pass ratio of the engine, but furthermore gets relatively fast to a point, in which the efficiency gain is completely compensated by the effect of extra weight. For this reason a geometric boundary limit exists, in which the installation of engines of increased dimension and with greater diameter below the wings of short range aircraft does not lead to any efficiency gain any more.

A second physical constraint also results from the necessarily larger diameter of the fan of the turbofan-engine. As the fan, acting as a compressor is deeply embedded in the thermodynamic cycle of the engine a specific minimum rpm for the low pressure drive shaft results, on which also the low pressure turbines stages are mounted. This minimum rpm reaches its maximum during take-off phase, when the maximum level of thrust is required. With the increased diameter of the fan, despite the relatively low rpm of the low pressure turbine and fan, the velocity relative to the fluid becomes supersonic at the tips of the fan blades. In the Airbus A320 and its considered reference engine, CFM 56, a Mach number of 1.4 is reached at the tip of the fan blades during take-off.

This high Ma-number, resulting in highly disadvantageous flow conditions, on one hand leads to loss in efficiency for thrust generation, but also results in a high increase in noise emissions from the fan, especially from the outer region near the blades tips. During take-off and climb, these increased noise emissions become exceptionally perceptible and thereby enlarging the noise footprint of the aircraft in the vicinity of the airports.

One solution for partly overcoming this challenge comes from the installation of a reduction gear between the low pressure drive shaft of the engine and the fan. This enables the fan to be flown at lower rpm and therefore lowering tip velocity of the fan blades, but at the same time allows the low pressure turbine to run at a higher rpm for better efficiency. With the “geared-turbofan” architecture lower fan tip speed can be achieved, thereby reducing noise and improving efficiency. Disadvantages of this technology are that the reduction unit is limited to certain ratios and increases the engine weight. But most importantly the technology does not help overcome the other two of the previously mentioned challenges, i.e. the increase in the nacelle’s dimension and its impact on the drag and the issues related to the ground clearance.

With an increasing size of the engine the nacelle surrounding grows both in dimensions and in wetted area. As a large amount of the geometric area of the nacelle is exposed to the fluid, outer as well as inner side, along with the wetted area the zero-lift drag of the aircraft will also increase, which is especially disadvantageous in cruise flight conditions and hence lowers aircraft- and fuel performance. A basic rule of thumb states, that the drag of the engine’s nacelle is proportionate to the square of the fan diameter [1]. Apart from additional zero-lift drag, with a large nacelles additional interference drag has to be taken into consideration, too.

4.2.2 Inliner - Methods to enhance the propulsive efficiency

The previously mentioned challenges regarding nacelle design and engine integration are all non-excitant in Inliner configuration. Both of the Fans rotate open in the fluid at high efficiency. Unlike with currently or former known “Open Rotor Technology” there is no engine nacelle or pylon needed, not even a small one for the core of the engine. The omission of the surrounding engine nacelles leads to a higher propulsion efficiency of the Open Fans, resulting in higher overall efficiency and in lower fuel consumption, especially in cruise flight.

A more adequate term to describe the propulsion device of the Inliner would be “Open Fan” because its aerodynamic layout and blade design, also in terms of noise generation, is completely different from the technology known as “Open Rotor Technology”. Because of its design, it is also completely different from the previously named “Propfan Technology”.

By rotating open in the surrounding air the fans need no surrounding casing, unlike conventional turbofan-engines, which feature a nacelle. By the omission of the nacelles the Inliner configuration, in comparison to the reference aircraft Airbus A320, has a reduction in the wetted area of 98 m², which is close to 80% of the geometric reference area of the A320 wings. Although a casing would be beneficial at take-off and generally at very low flying speeds to slightly increase the maximum thrust level, at higher speeds this becomes increasingly disadvantageous due to the additional drag. Thus, by this first characteristic of Open Fan design the propulsive efficiency is significantly enhanced, especially during cruise.

The fan area of the Inliner is characterized by a significantly large geometric area. Thus, a beneficial low specific thrust and a profitable low fan pressure ratio can be achieved, both of which positively affect the overall efficiency and the noise emissions of the aircraft. The Open Fans of the Inliner are based on a large geometric ring element. To obtain such a large fan area the inner diameter of the ring element has to be maximized, while the span of the blades, making up the radial extension of the rotor, has to be optimized to a beneficial geometric ratio. The blade span should ideally be half of the inner radius of the ring element.

Aircraft	Approximate ground clearance of fan/propeller in cm
A320 / Inliner	65
Saab 2000/340	51
Boeing 737-800	65

FIG 7. Ground clearance of aircraft engines [26]

As can be seen in Figure 8 with a constant rotor blade span, which influences the profile drag and thus its effectiveness, around 7.5 times larger geometric rotor area can be obtained by the Inliner configuration compared to the conventional configuration.

Another important characteristic to the unique propulsion architecture of the Inliner is that the Open Fans are arranged encircling the cylindrical proportion of the fuselage

cross section. Hence, the inner diameter of the Open Fan is approximately equal to the outside diameter of the fuselage, here 4 m. A further constraint, on the length of the fan blades, comes from the ground clearance, which depends on the arrangement and design of the landing gear. In Figure 7 propeller- and turbofan- driven airliners' ground clearance can be seen. The ground clearance for the Inliner is chosen to be kept unchanged at 0.65m as in by the reference aircraft A320. This value is in line with other commercial aircraft of this type.

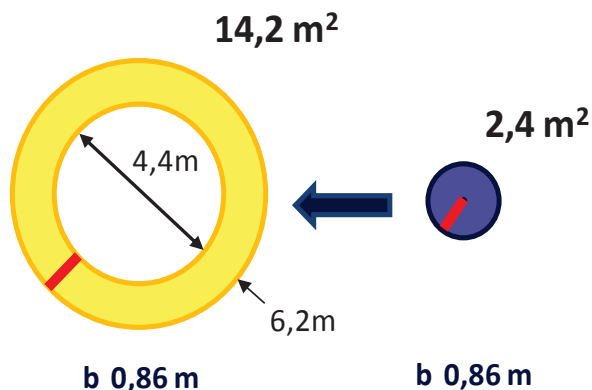

FIG 8. With the same blade span, which is a very first indicator for the profile drag of the blade, pointing at its effectiveness, a significantly larger geometric rotor area can be reached, here around 7.5 times larger, if the hub area is considered omitted at the reference engine (r), too.

The two Open Fans will be counter-rotating, thus, enabling the second rotor to recover swirl from the first rotor according to the concept of swirl recovery. This results in an efficiency gain of the fan. During cruise flight this enhancement in efficiency is around 8% according to [8,9]. Some sources state that during take-off there could be as much as a 12% gain in rotor efficiency [9]. Along with the improved conversion of shaft power to thrust by the Open Fans, there is an overall efficiency improvement for the propulsion system.

A further advantage is that the reaction moment on the fuselage, which occurs while the Open Fan is in rotation, is compensated by the contrarily reaction moment of the second Open Fan resulting in no momentum acting on the fuselage, as long as there is no failure of one Open Fan or its dedicated driving engine.

In the Inliner configuration there is spatial separation between the power generating turbines and the Open Fans converting the power into propulsive thrust. Due to this the Open Fans could easily be equipped with variable blade-pitch technology. A variable-pitch fan blade mechanism allows for variation in the angles of incident of the propeller blades. This allows for increased propulsive efficiency throughout a larger range of flight speeds. Amongst turbo-prop aircraft, this capability of variable blade pitch is known for its significantly increase fuel-efficiency. Especially during the climb phase, when aircraft fly with moderate speeds, large efficiency gains can be made. This is especially important, as on short range mission's the flight phases with moderate speeds, especially climb,

play a major role sometimes even greater than the cruise phase in terms of fuel consumption.

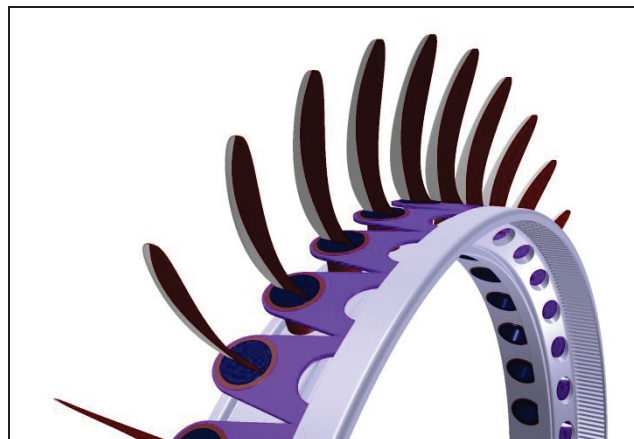

FIG 9. Central Component of a variable-pitch Open Fan with integrated gear ring and 36 adjustable blades

By conventional turbofan-powered aircraft power and thrust generation is integrated in one engine-casing and both mechanically and thermodynamically coupled. If a fan of a turbofan-engine would be equipped with variable-pitch blades, the adjustment of the blades (changes speed, direction of speed and pressure level) would not only have an effect on the thrust generation, but also on power generation. This mechanical and thermodynamic coupling within the jet engine makes variable pitch at the fan very complex in conventional engines.

Enhancement of the propulsive efficiency by	Enhancement in mission fuel/ source
Fans operate as Open Fans	18.7% [26]
Significantly enlarged geometric rotor area	
Rotor area as a ring element encircling the fuselage	
Variable pitch fans	
Swirl recovery by counter-rotating fan system	
Reduction gear involves in power transmission for efficiency	
Mechanical losses in power transmission and reduction gear	
Installation losses due to the installation of the fans	
Total	18.7%

FIG10. Technical measures for a combined effort for significantly enhancing the propulsive efficiency

The mechanical power of each of the turboprop/ turboshaft engines is transferred by a transmission shaft to one specific Open Fan. Between the transmission shaft and the fan a reduction gear is anticipated, which is directly integrated in the rotating ring structure of the Open Fan. This

leads to a lightweight solution for both components - reduction gear and Open Fan. As can be seen in Figure 11 the outer and geared ring is driven by a bevel gear which is connected to the drive shaft. The transmission of power can also be obtained by more than one bevel gears, being coupled to the outer geared ring.

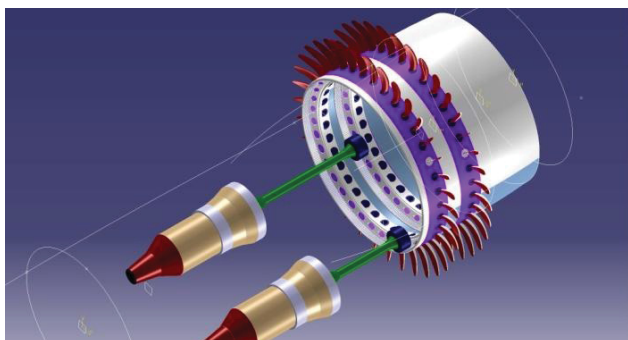

FIG 11. Simplified actuation of the rotors in principle by here only one bevel gear, one reverse planetary gear is integrated in one bevel gear (here not observable).

This integrated solution does have the advantage that the geometry of the diameter of the fuselage's cross section fits very well to the required gear ratio, here of 11.6 : 1. In this way the diameter of the larger gear of 4.4 m is determined by the diameter of the outside fuselage 4.0 m. The resulting diameter of the bevel gear is around 0.38 m and is easy to be integrated in the unpressurized space, which develops by the lateral extension of the main landing gear bay to the front, finally covering partly the former area of the front cargo bay.

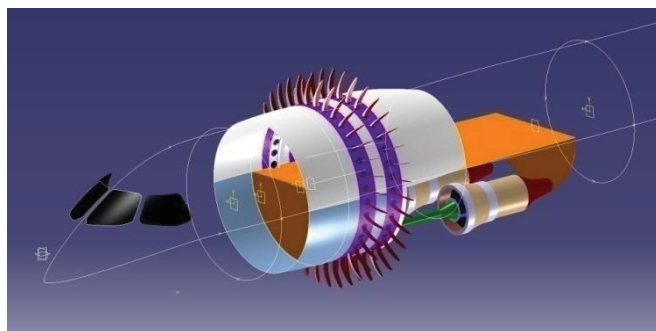

FIG 12. Two turboprop-engines each drive one dedicated Open Fan via a transmission shaft and are installed in an unpressurized area, resulting from the elongation of the main landing gear bay to the front, partly covering the former area of the front cargo bay

4.3 Inliner - Enhancement of the Thermodynamic efficiency

The thermodynamic efficiency of the turboprop and turbo-shaft engines can be improved by special technical recuperative measures. These measures can include intermediate cooling of the compressor stages, fuel preheating and heat-exchangers, located in the exhaust gases of the engines. One advantage, which comes from the unique configuration of the Inliner is that these recuperative measures are most effective if the overall pressure ratio of the engines OPR is low [4]. In line with the Inliner concept the modern turboprop-engines, more specific this type of

engines, have a both relatively low pressure ratio in general and furthermore feature a comparatively simple architecture, which makes it easier to integrate these technical measures. Hence, in contrast to turbofan-engines, where this technology is common the recuperative measures are more efficient with turboprop engines and easier to integrate. The fuel saving potential might be even higher. In [4] there is a concept turprop-engine for a submarine searching aircraft presented where fuel savings by recuperative means are projected to lead to a sfc improvement of 36%.

Enhancement of the thermodynamic efficiency by one or more of this technical measures	Enhancement in mission fuel/ source
Intermediate cooling at the compressor stages	} 6.0%
Pre-heating of fuel	
Recuperator installed in the exhaust area	
Total potential seen far beyond up to 36% [4]	6.0%

FIG 13. Technical measures for an enhancement of the thermodynamic efficiency leads to 6% fuel savings

4.4 Inliner - Weight

Although less weight would lead to further fuel savings, the propulsion architecture of the Inliner will lead to extra weight on an aircraft level, compared to the reference aircraft Airbus A320. More detail on the increased weight of the Inliner configuration will be discussed in detail later on in this paper. Despite the increased weight leading to increase in fuel consumption, this compensated and far outweighed by the fuel savings of the Inliner configuration.

Historically, there have been changes in the propulsion architecture of airliners that lead to major fuel savings but also were accompanied by extra weight e.g. the shift from turbojet to turbofan engines or the replacement of turbofan by geared turbofan engines.

5 GENERAL CHALLENGES OF AN OPEN-ROTOR INTEGRATION

With the Inliner aircraft configuration two most inherent problems of former open rotor configurations - rotor burst - and - noise - can be solved.

Open Rotor Integration needs to address three distinct challenges, whereby two of them are interlinked. First, significant noise emission, predominantly emitted radially in the rotor plane, is produced by the high rotor blade tip speeds. These result in increased perceived noise levels, especially in the proximity of airports by aircraft taking off and climbing. Second, the supersonic and partially transient airflow over the rotor blade tips result in oscillations that due to the length of the blades result in vibration and noise emission that also make their way through the ex-

tent of the blade into the airframe and passenger cabin - both radiated through air and through the aircraft structure. This causes an increase in cabin noise levels.

Third, present-day safety requirements dictate that for the sake of redundancy, aircraft need at least two independent engines. Open-rotor engines are characterized by fan blades that rotate freely without a surrounding cowling. For a thorough safety assessment it has to be considered that a structural or component failure of the engine could result in rotor parts being hurled in a radial direction due to the centrifugal force acting on them. This is also known as an Uncontained Engine Failure.

As opposed to turbofan engines, the higher rotational speed of the rotors, their comparatively larger fan diameter and the higher mass of the rotational elements of the engine, result in an increased kinetic energy of any damaged engine parts or debris that in case of an uncontained engine failure is slung out of the engine. The high kinetic energy of such failed components poses an increased damage risk of vital aircraft components such as the pressurized cabin, fuel tanks, flight controls as well as the hydraulic and other vital systems. For this reason the positioning of such propulsion systems has to be done with great precaution to minimize potential negative impact such that one engine's debris, in the case of an engine failure, does not damage the other engine, thus eliminating the redundancy between them. Many current day open-rotor configurations tend not to take this highly relevant safety factor into full consideration to assure full redundancy between the engines (see figure 15 and 16).

Defining the placement of an open-rotor engine in a manner that ensures the minimization of the above mentioned safety issue can basically be done using the following method, also see figure 14. On a plane including the longitudinal axis of the aircraft engine, a cone is defined with its tip at the root of a propeller blade and stretching out in the same direction as the blade itself. The angle enclosed by the tip of the cone, e.g. $2 \times 15^\circ$, has to be chosen in such a manner that any debris slung out of the engine due to centrifugal force on that plane will statistically stay within the enclosed area of the cone. Defining the cone as infinitely high and rotating it 360° around the rotational axis of the engine will define a torus like volume of revolution.

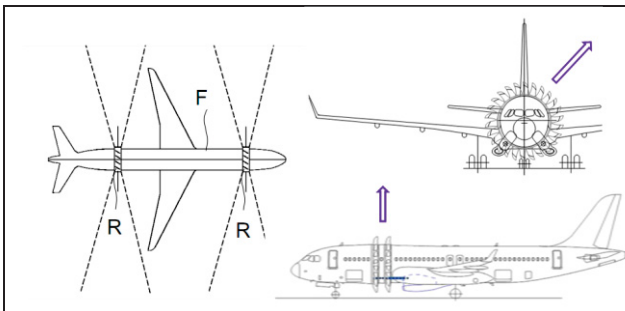

Fig 14. With the Inliner configuration the Open Fans can be arranged at the aircraft the very first time in a way, that no vital components lie in the danger zones of the fans and therefore can not be hit in case of rotor burst and blade-off.

This danger zone now defines the space in which debris could be flung in the case of an uncontained engine failure. Safe positioning of the open-rotor engine can be done by assuring that for each engine the above defined danger

zone does not include other engines, the pressurized cabin, control surfaces or any other vital systems of the aircraft, such as the flight control system, high-lift devices, hydraulic system, etc.

Due to the uncontained engine failure there are, however, tight limits as to the possible positioning of Open-Rotor engines on a passenger aircraft. On twin engine aircraft the positioning of open-rotor engines have thus far only been done in rather unfavourable configurations. The engines are placed at the rear of the aircraft, behind the pressurized area of the cabin on either side of the vertical stabilizer, which has to act as a shield between the two engines. In the case of an engine failure the vertical stabilizer would protect the functional engine from any debris that might be ejected from the faulty engine. However, whether the vertical stabilizer could practically be built in such a manner that it structurally could serve this purpose remains a controversial matter.



Fig15. Example of a proposed aircraft concept using the open-rotor engine architecture with aft mounted engines in questionable side by side arrangement [12].

An alternative option is to place the engines at the rear of the aircraft behind the pressurized cabin, but with offsets along the longitudinal axis of the aircraft to such an extent that any debris leaving one engine would miss the other engine. This does solve the problem to a certain extent; however, it is not a sustainable solution as it does not ensure that other vital aircraft components in the proximity to engine are not hit. In addition, this configuration also results in asymmetric thrust generation.

Further implications arise in terms of the aircraft's centre of gravity by the rear placement of the engines. Having a relatively large weight and being placed so far from the aircraft's CG, there is a reduction of flexibility in loading of cargo and fuel which also reduces the versatility of usage of the aircraft. Additionally, rear-mounted engines require relatively heavy T-tail configurations.

6. INLINER CONFIGURATION

6.1 Baseline reference Aircraft

For the purpose of investigating the possibilities of implementing the engine architecture on a commercial airliner, the following reference aircraft has been chosen: an Airbus A320-214, typically capable of carrying 150-180 passengers and considered to be a state-of-the-art aircraft in the year 2000. The take-off weight of the aircraft is set to 60t to represent a common short-haul flight with 2/3 of the

maximum payload capability of circa 20t, which corresponds with the design payload of the aircraft [14]. The Inliner propulsion architecture will be applied on the baseline reference aircraft in the following sections of this paper. The effects on fuel consumption, noise and emissions will be calculated and finally compared with the reference aircraft, again.

6.2 Engines of the reference aircraft

The CFM 56-5B4 having a by-pass ratio of 5.7:1, a fan diameter of 1.73m, a maximum thrust of 120.2kN and dry weight of 2,380kg will be used as the reference turbofan engine.

To calculate the fuel consumption, a typical high speed cruise of M0.78 at 30,000ft is chosen, which is relatively close to the best range speed. The best achievable thermodynamic efficiency of the aircraft is estimated to be 0.440. Using equation [(2) of [26]], this yields an overall propulsion efficiency of:

$$\eta_{VOR,RF}=0.722.$$

This will be used as reference in further calculations.

Reference aircraft as well as engine configuration are representative of technology levels as in year 2000 and are thus inline with the ACARE references [1].

6.3 Engines of the Inliner

For the Inliner concept a pair of modern turboprop or turboshaft engines could be chosen to drive the two Open Fans. One possibility would be to use the Europrop TP400, which produces a maximum equivalent shaft power of 8200kW and powers the Airbus A 400M military transport aircraft. It is currently seen as the most powerful and modern western built turboprop engine. The dry weight of one engine is 1980 kg.

With two TP400 the Inliner could be safely propelled in all flight regimes up to a maximum take-off weight of around 66 000kg and up to altitudes of approximately 30 000 ft. If the take-off weight or altitude needs to be increased a more powerful turboprop or turboshaft engine could be chosen. For this a closer look could be taken at Russian manufacturers who have powerful and lightweight engines that could propel the Inliner.

For turboprop-engines, instead of the Specific Fuel Consumption (SFC) the Prop Specific Fuel Consumption (PSFC) is used to measure the characteristic fuel efficiency of the engine. The PSFC can be calculated according to [15] with the turbine entry temperature (TET) and the overall pressure ratio (OAPR) of the engine using the following formula. The TET is assumed to be 1550 K for the Europrop TP 400.

$$PSFC = 2,56 \cdot 10^{-4} - \ln(P_{eq,ssl} \cdot OAPR \cdot T_{TET}) \cdot 10^{-5} \quad (1)$$

Using (1) results a PSFC according to [15] of:

$$6,02322 \cdot 10^{-5} \frac{kg}{kWh} \text{ or } 0,21684 \frac{kg}{kWh}$$

6.4 Positioning of the Open Fans at the Inliner

Prior to the positioning of the Open Fans on the Inliner certain considerations have to be made.

Taking into account the potential failure of one rotor or its dedicated engine, for safety reasons and in line with redundancy requirements, there must be at least two rotors for propelling the aircraft. The positions of these Open



Fig 16. Placing the Open-Rotor engines beside each other, in a way similar to turbofan engines, can result in a dangerous scenario where in the case of a Rotor Burst the functioning engine gets damaged by the failed engine [13].

Fans on the aircraft have to be chosen carefully considering many factors.

One possibility is to install one or two rotors, encircling the fuselage at the aft fuselage region behind the wing and in front of the empennage. This solution might be appropriate for rotors with a relatively low blade span and thus a relatively small overall diameter. Due to their small size however, these rotors don't provide significant improvement of the propulsive efficiency, but are rather implemented for the purpose of a slight reduction of fuel burn by boundary layer ingestion, also known as BLI.

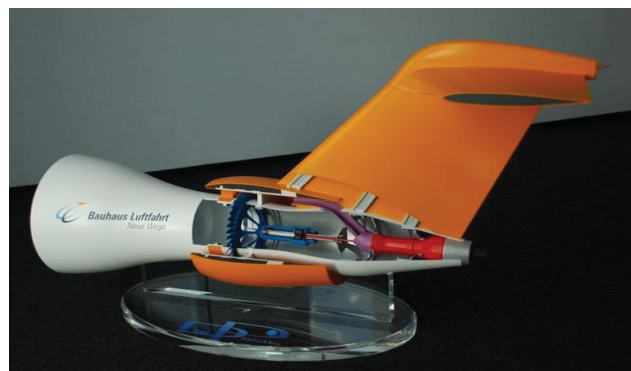

Fig 17. The positioning of fans in the aft fuselage region is appropriate for fans with relatively low diameter and blade span, focused on fuselage boundary ingestion (BLI), which leads to fuel savings of about 10%. For a significant enhancement of the propulsive efficiency with fuel saving potential of 30% and more fans have to be designed different, especially dismantled, thus open, and with a significantly higher diameter and blade span and could not be any more reasonably positioned in the rear fuselage because of geometric constraints and noise.

The rotors, if they are designed to boost the efficiency dramatically, have to have on the one hand a sufficient span of the rotor blades, including a suitable aspect ratio, and on the other hand, while rotating, the blades must form an ideally maximized geometric rotor area. Therefore, the inner diameter of the rotor, which is determined by the outside diameter of the fuselage, has to be as large as possible. But disadvantageously at the rear fuselage the outside diameter of the fuselage becomes geometrically smaller and smaller due to the contraction of the fuselage. That is why an aft rotor position does not contribute to higher efficiency on a greater level.

tendency is true that for lift generation the upper side of the wing is generally dominant. Furthermore, lift is generated by a pressure difference between upper and lower side of the wing which can be easily seen under appropriate meteorological conditions by vortexes, which occur as a result of pressure equalization at the wingtips. For a most efficient and primarily quiet operation of the aircraft, the incoming air stream entering the whole geometric area of the propulsors should be as homogeneous and three-dimensionally steady as possible. With a downstream-installation of the rotors behind the wing the

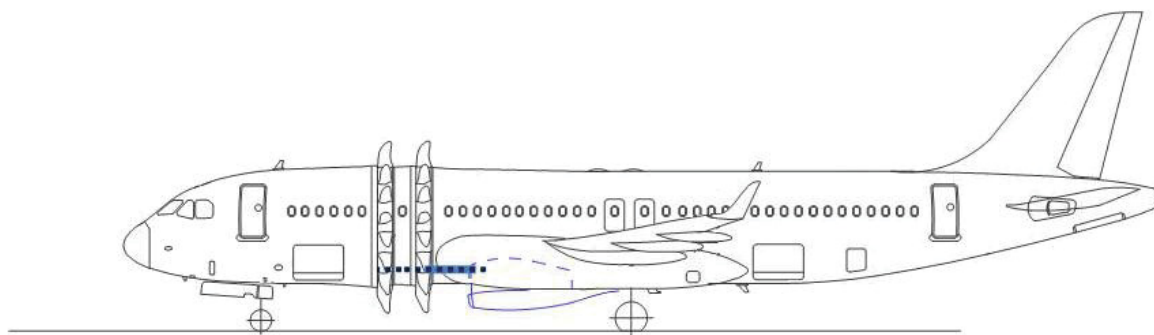

Fig 18. Side view of the Inliner configuration with counter-rotating Open Fans installation in front of the wings

Figure 8 shows an example comparison of a conventional rotor of the A320 CFM reference engine and an example rotor design for a superefficient aircraft, featuring the same blade lengths as the reference engine however with an inner diameter that is enlarged to match the outside diameter of the fuselage of the Airbus A320. It shows that with an unchanged original rotor blade length, which is also the main driver of the specific aerodynamic zero profile drag of the rotor blade, a 7.5 times greater geometric rotor area can be achieved.

Further, an airliner both rotates and derotates around its main landing gear during take-off and landing. With an aft installation of the rotors the ground clearance of the rotors would diminish critically in such a way, that the required angular ground clearance of around 11° to 13° at the aft fuselage region can not be fulfilled any more. This geometric constraint inhibits the installation of a rotor with a larger fan blade diameter behind the wings as it would risk striking the ground during take-off or landing. Elongating the landing gear legs would result in extra weight, also meaning a fuel penalty. It would also lead to geometric challenges at the main landing gear, because the main landing gear legs are retracted by a face-to-face mechanism. Besides there is an increased danger of foreign object damage, FOD to the rotors, due to the decreased ground clearance for the aircraft, when in take-off run.

The most important reason, why an aft position of the rotors is furthermore doubtful refers to the noise, being generated by the rotors. In flight lift is generally produced by the wings. There is a simple rule of thumb, saying that 2/3 of the lift generated is produced by the upper side of the wing by underpressure, while around 1/3 of the lift is generated at the lower side of the wing by overpressure fields. This rule however is simplified, because the pressure distribution at the wing depends on the detailed aerodynamic design with several factors of influence, but the

incoming airstream would enter the geometric rotor area with dramatically significant differences in pressure and speed, mainly resulting from the pressure difference between upper and lower side of the wing, which is just responsible for the lift generation of the aircraft.

In consequence there will be a loss in efficiency. Above all, there will be a remarkable undesirable increase in noise, as the blades of the Open Fans rotate and work in an aerodynamic flow environment which is highly disturbed by the wing and its pressure difference between upper and low side of the wing. A major increase in outside noise is known from many aircraft with aft propeller installation, located downstream of its wings e.g. the P-180 Piaggio Avanti, the speed canard, Vari EZ, Cozy, Velocity and the Beechcraft Starship.

Fig 19. The placement of fans behind the wing is highly unfavorable in terms of rotation, derotation and noise [28].

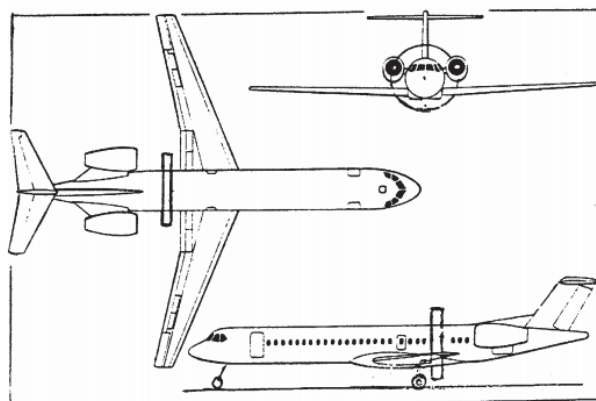

Another reason why an aft placement at the fuselage for highly efficient rotors is unfavorable is that the rotors have their own weight while they are in rotation. According to the physical effect of precession, significant forces occur at the rotors in vertical and spanwise direction, both because of the weight of the rotors and in reaction to maneuvers flown by the airplane. As both rotors are counter-rotating, in normal operation of the aircraft, these forces normally will cancel each other out so, that there is no resulting force acting on the aircraft.

for maintenance and replacement, without being itself completely disintegrated. With an aft position this is impossible because in front there is the wing and behind the empennage. So it can not be detracted, neither to the front, nor to the rear of the fuselage.

In consequence, the most favorable position for placing the rotors at the aircraft at the fuselage is in front of the wing. The incoming air flow of the rotors is undisturbed and mostly three-dimensionally steady in speed and pres-

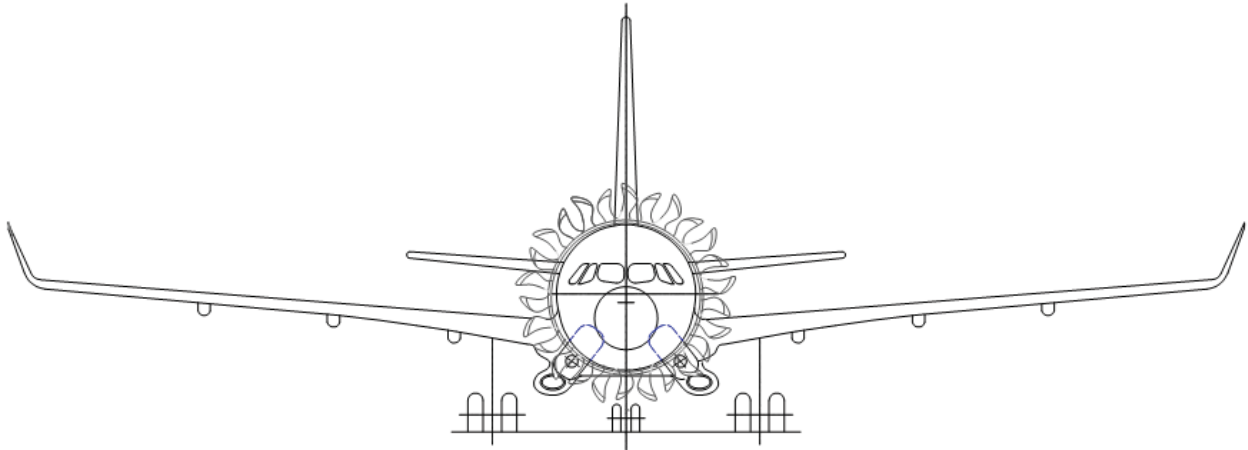

Fig 20. Front view of the Inliner configuration [26]. The intakes for the TP-engines are comparatively 6-times smaller.

However, after one rotor or dedicated engine failure, these forces are not being compensated any more, and in this case they do have an effect on the aircraft. The effect, more specific the moment, depends on the characteristic length of the level arm ranging from the point of application of the force of that rotor still in operation to the center of gravity of the aircraft. This level arm should be as short as possible to minimize the effects of this force i.e. the moment on the aircraft. As exactly the empennage installation has to compensate these forces in One Engine Out (OEI) conditions, the level arm from the CG to the empennage installation has in contrast to be ideally maximized in length.

In the scope of an aft installation of the rotors, they have to be installed in the very back of the fuselage behind the passenger cabin (because of over wing emergency, the rear door emergency exits and the cargo doors), probably behind the pressurized part of the fuselage. As already stated at this position not only the outside fuselage diameter is lower due to the contraction of the fuselage, also the ground clearance is too low at take-off and landing and the incoming airstream is strongly disturbed by the wings, which results in a noisy operation. At the same time the specific level arm from the rotors to the CG is disadvantageously long, nearly as long as the level arm to the empennage. This makes forces in one engine out conditions OEI difficult to be generally compensated and will moreover demand for an increased geometric area of the empennage installation, resulting in unfavorable, supplemental drag and weight.

A further reason is that the rotors, while they are in operation, are structurally heavily loaded and therefore the core component, which takes the main radial loads, will be realistically made as one integrated structural part, like a ring. By this means the rotor can be made lightweight and is more easily balanced for rotation. As a consequence, the rotor ring must be easily detachable from the aircraft

sure. This allows an efficient, but especially quiet operation of the rotors.

At the same time both rotors are placed between nose gear and the main landing gear. This means that the propellers have a steady ground clearance, which is even enlarged in transition phases when the aircraft rotates and derotates. As the rotors are installed in front of the wing, approximately at that longitudinal position of the fans of the reference aircraft, the lever arm to the center of gravity is very short so - that occurring forces due to the precession in one engine out conditions - can be easily handled and compensated with the lever arm of the empennage, which is remarkably longer. Thus, the geometric area of the empennage does not need to be increased and can remain stable.

Finally, the rotors can be easily dismantled to the front of the aircraft in one piece without being disintegrated. According to figure 21 the ground handling in general nearly stays the same like with the reference aircraft. All ground vehicles can reach the aircraft without changing their positions.

Altogether the front position of the rotors in front of the wing is favorable in terms of an efficient and quiet operation and allows easy ground handling of the aircraft, a general safe operation and a comfortable replacement and maintenance of the rotors.

7 BENEFITS OF THE INLINER CONFIGURATION

The application of the Inliner architecture on an airliner has a series of benefits.

As explained the Open Fans and engines do not necessarily have to be placed at the rear of the aircraft. They TP-engines (turboprop-engines) can now be placed at the center of the aircraft, semi-buried in the fuselage to reduce drag, for example, in an unpressurised area just ahead of

the main landing gear bay. Like with helicopters they can be placed inside in a semi-buried position with providing sufficient cooling for the turbines. The engines' close proximity to the aircraft centre of gravity will result in low moments of inertia, increasing the aircraft agility and reducing the necessary size of the control and stabilization surfaces.

Further, this configuration like the Inliner allows for a larger permissible CG range in comparison to a conventional aircraft with the same size of horizontal stabilizer. The possibility of storing fuel in the wings of the aircraft remains, resulting in smaller shift of the centre of gravity due to the fuel consumed compared to aircrafts with rear mounted engines. Conclusively, a greater flexibility can be granted when it comes to the loading of the aircraft, but also trim drag is reduced when the position of the centre of gravity deviates from the normal.

In the case of a fault in the fuel system fuel can still be 'gravity fed' to the engines because the engines are located below the wings.

With the new configuration, the need of a T-tail can be avoided. This means a reduction in weight as this configuration tends to be heavier than conventional tail configurations, especially when equipped with a THS (Trimmable Horizontal Stabilizer), as can commonly be seen on nearly most commercial aircrafts today. It can be further noted that due to the large thrust area of the Inliner there is only slight increase of dynamic pressure over the empennage potentially resulting in a lower demanded area for the horizontal stabilizer. The maximum increase in the speed of the airflow is calculated to be 18.7m/s during cruise and 22m/s during take-off. In reality, however, these speeds will be lower due to pressure losses.

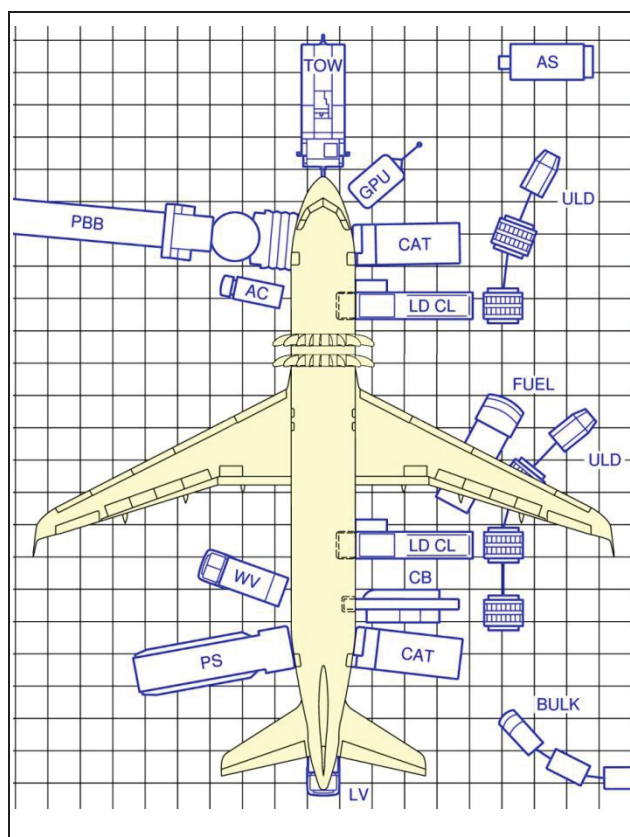

Figure 21. The ground handling of the Inliner in general stays the same like with the baseline reference aircraft

The support structure's weight for the engines can be kept significantly low due its positioning close to the aircraft's CG, which allows for a short load path and a proximity to the wing box, which is designed to take up high loads. Placing the engine semi-buried in the fuselage means that most of the engine nacelle is not needed, especially as only the air inlets are placed outside of the fuselage. As conventional nacelles are usually designed to withstand bird strikes and often include the thrust reversers, they tend to be relatively heavy, two of them weighing around 1,600 kg on the reference A320 aircraft.

Connecting aircraft systems such as hydraulics, bleed air, air conditioning and electricity supply is simplified due to the engines' location within the fuselage, but there is also significantly much more volume available for the lightweight integration of systems and engines' accessories. Good accessibility from downwards exists both for the engine and the aircraft sub-systems, facilitating easy exchange and maintenance of these parts.

Not having a restriction on volume allows for special measures to increase the thermodynamic efficiency of the turboprop engines to a greater extent with, for example by recuperating devices, allowing for further reduction in the specific fuel consumption. Further synergies can be found between the aircraft anti-ice system and the recuperating system with such a configuration.

In general a reverse installation of the turboprop engines, as known from many of today's turboprop-engines installations, which demand for a 180 degree redirection of the incoming/outcoming air flow of the engine with typical losses in efficiency, might not be required any more. This helps to further improve the specific fuel consumption as can be additionally observed by the Piaggio Avanti P180. According to the turboprop concept the exhaust of the engines does contribute to the overall thrust level only to a very low extent. In the scope of the Inliner concept the exhaust gases could potentially be directed out of the aircraft in such a special way - as they accelerate the boundary layer at the aft downside belly of the aircraft and therefore help to prevent a separation of the airflow at the aft downside fuselage. This might slightly lower the fuselage drag. Further, due to the installation of the turbine partly within the aircraft belly, core noise emitted from the turbines and compressors can be shielded well to the outside, as well as to the inside.

The architecture of the Open Fans being placed like a ring around the fuselage assures that in case of a failure of a rotor blade no debris is slung in a direction that could harm any vital aircraft components. This allows for the Open Fans to be placed close to the aircraft's centre of gravity.

A very high geometric by-pass ratio of 24.5 can be achieved without the drastic increase of wetted area through the engine nacelles and with an excellent thermodynamic efficiency. However the relevant by-pass ratio to estimate and quantify fuel consumption is even significantly higher due to further accompanied measures, which, however they are effective, do not directly influence the present and obvious *geometric* by-pass ratio.

By the Inliner configuration the engines' nacelles and pylons are not any more needed which saves weight and above all reduces overall aircraft drag by 6% during cruise (this takes into account in general the additional wetted area of the Inliner as well as wetted area for air inlets and exhausts). With a freely single rotating open fan, a propulsion efficiency of 0.88 can be achieved and even further

increased by using two concentric counter-rotating Open Fans. This would mean that the torque produced by the rotors would cancel each other out.

The overall fan-pressure-ratio for both fans in cruise is here 1.090, that however, depending on the aerodynamic layout, can be selectively split up among the two fans, for example equally at 1.044 for each fan. The beneficially low overall fan pressure ratio is caused by the profitable large fan area of the engines – 14,3m², being a drastic increase in comparison to the reference aircraft (of two times 2m²), but less than the geometric propeller area of one A400M engine (22m²).

The large fan area is reached with nearly the same blade span like within the CFM reference engine - a result of the large diameter of the inner ring onto which the roots of the rotor blades are fixed. Efficiency-wise, the prominent areas of a propeller blade are at 70-75% of the blade length as its speed close to the root is near zero and at its tips can be transonic. The rotor of the Inliner could be comparable to a large propeller, missing the inefficient inner part. As there is much smaller variation between the root and tip velocity of the rotor blades, less blade twist is needed, resulting in increased efficiency and lower blade weight. Compared to open rotor engines with similar or even smaller fan area, the Inliner has much shorter rotor blades and is therefore much less prone to vibrations that amongst others could result in increased noise emissions. Further, significant less torque is excreted on the root of each blade. Above all fan noise is significantly decreased due to the lower rotational speed of the larger rotor. A reduction gear is used to achieve the optimal relationship between the most efficient rotation speed of the turboprop engine and the fan. Due to the slow rotational speed of the rotor, on the initial design the effective inflow Mach number on the blade tips, taking into account the sweep and tapering, is noncritical in all flight phases. It peaks at a maximum of Ma 0.82 in cruise (without considering the sweep and taper it would be 1.08).

The emitted noise from the rotors is proportional to the 4th power of its rotational speed [1], which means that compared to the fan of the reference CFM engine at Ma 1.4 and a blade tip speed of 470m/s, at the Inliner configuration the tip speeds are reduced by 54.6% and the noise emission of the fan could be reduced by 52.7% at take-off. During take-off, the initially calculated rotor blade tip speeds therefore stay at Ma 0.77 which is even lower than that the blades' tip speed of the Airbus A400M that has already successfully qualified according to the IACO noise requirements of Chapter 4 Annex 16.

However at the Inliner the real present effective Ma at the tip of the blades in take-off conditions is with Ma 0.58 even significantly comparable lower - taking into account the sweep and taper of the Open Fans' blades.

In a relatively uncomplicated manner, actuators could be installed on the rotor ring to enable each blade's angle of incidence to be individually adjusted. This further increases the propulsive efficiency in all phases of flight. Similar to turboprop engines, better performance and lower fuel consumption can be achieved, especially during take-off and climb. Apart from the cruise phase, especially in climb, the 25 – 40% improvement in fuel consumption known from open-rotor configurations, can thus be improved even further [1,P.2].

7.1 Outward Noise Level of the Inliner

Reduction in the outward emitted noise level of the Inliner was calculated to be in the range of -67% to -75% in intensity. This refers to the perceived noise levels that take into account the varying sensitivity of the human ear at different frequencies. This reduction comes from a decrease in all three main types of noise emitted by the aircraft's engines.

7.1.1 Noise generated by the emission of jet exhaust gases at the engines

The noise generated by the exhaust gases is the dominating source of noise emissions in state-of-the-art turbofan-propelled aircraft. Especially during take-off and initial climb the noise footprint on the ground in the vicinity of airports is significantly dominated by this type of noise.

In general the noise level of the exhaust jet is proportional to the exhaust gas speed to the power of 8 [27]. With current conventional turbofan engines the maximum exhaust jet's speed is around 450 m/s, while with turboprop-engines the maximum exhaust gas speed is 1.88 times smaller, around 240 m/s. With this significant decrease in the exhaust gas speed, the noise level, generated by the exhaust jet is reduced by approximately - 21.8 dB [27].

As can be seen in Figure 22, for the human audible perception this equals a reduction in perceived noise intensity of around 75%, meaning the jet engine noise is only 1/4 of the former reference noise level.

Keeping this in mind, it can be expected, that noise generated from the jet exhaust gases will be so low that it will not be perceivable as a significant contribution to the overall noise level. This same effect is heard with turboprop powered aircraft, in which noise of the exhaust gas jet does not play any major role in the overall perceived noise level, neither in general nor especially during take-off and climb.



Variation in level	Loudness by human perception	Effective sound pressure	Acoustic intensity
			
Decibel dB	loudness factor	sound field factor	sound energy factor
+20	4,000	10,000	100,000
+10	2,000	3,160	10,000
+6	1,516	2,000	4,000
+3	1,232	1,414	2,000
+0	1,000	1,000	1,000
-3	0,812	0,707	0,500
-6	0,660	0,500	0,250
-10	0,500	0,316	0,100
-20	0,250	0,100	0,010

Fig 22. The second column states the delta in perceived intensity which is caused by a certain reduction in dB [translated from 33]

7.1.2 Noise of the Open Fans

The noise emitted by the Open Fans of the Inliner is important to be considered more in detail. Compared to the baseline aircraft of the Airbus A320 the fan pressure ratio at maximum take-off thrust is reduced from 1.51 of the conventional fan to just 1.06 for one single Open Fan and to 1.12 for the overall counter-rotating Open Fan System of the Inliner. At the same time the geometric rotor area for thrust generation is enlarged from 2 times 2m² of the Airbus A320 to 14.3 m² at the Inliner configuration. For a counter-rotating Open Fan system with two engines the geometric rotor area is only counted once - and not twice as usual with the conventional twin-engine baseline aircraft. Thus, thrust generation is distributed on a significant larger area and therefore there is a significantly lower increase in velocity being induced by the propulsors to the fluid for thrust generation. This results in a relevant outward noise reduction.

Maximum Thrust Brakes released $v_{TO} = 0$ @ SL

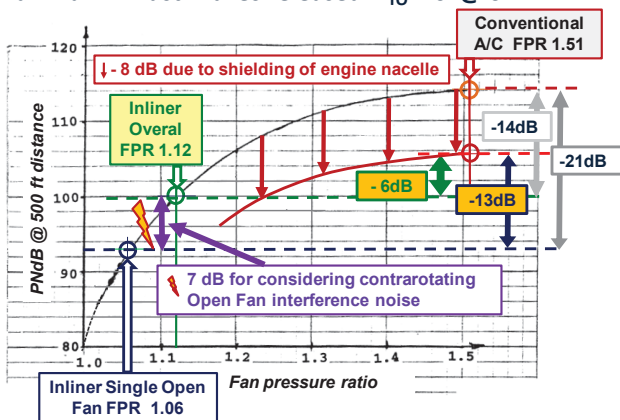

Fig 23. Reduction of the perceived fan noise in PNdB depending on the fan pressure ratio at a distance of 500 ft for maximum take - off thrust, shortly after the brakes of the aircraft have been released. The baseline fan reaches a FPR of 1.51 while the Inliner's single fan's FPR is only 1.06. This initially leads to a noise reduction of - 21dB. If the former FPR of 1.51 is compared with the overall Inliner's Fan system's FPR of 1.12 the noise reduction equals -14dB. The baseline engine's nacelle is expected to lead to a further shielding of fan noise at the baseline aircraft, resulting in an assumed outward noise reduction of -8 db. Taking this into account as an updated reference, the relevant noise reduction for the fan noise at the Inliner is still -6 dB, which equals a reduction in perceived intensity compared to the baseline aircraft of around - 33%, already taking into account that the fans at the Inliner operate open, thus without being mantled. Furthermore interference noise of the two counter-rotating fans has also been considered in this result by artificially increasing the FPR at the single rotors. By this around +7dB or roughly +40% in perceived noise intensity (see Figure 22), is added to a single fan with respect to the interference of both counter-rotating rotors.

Figure 23 shows the perceived outside noise level of a fan at a distance of 500 ft in db as a function of the fan pressure ratio (FPR), here specially shown for the maximum take-off thrust applied in take-off run, shortly after the brakes of the aircraft have been released. With decreasing fan pressure ratio the fan noise is reduced progressively.

For one single rotor of the Inliner the fan pressure ratio droops from 1.51 to 1.06, which initially equals a noise reduction of -21 dB [27]. According to figure 22 this initially means that the Inliner single fan's noise is only 1/4 of the reference's aircraft fan noise level.

The engine's nacelle has to be considered at the reference aircraft and is expected to lead to a further shielding of outside perceived fan noise at the baseline aircraft, resulting in an assumed outward noise reduction of -8 db. Considering this as an updated reference the relevant Inliner's noise reduction for the overall fan noise is still -6 dB, which equals a reduction in perceived intensity compared to the baseline aircraft of around - 33%, already taking into account that the fans at the Inliner operate open, thus without being mantled. The additional noise, here around +7dB, resulting from the interference of the two counter-rotating Open Fans is already relevantly considered in this result by an artificially increased FPR for the Inliner Open Fan system.

Climb after thrust cut-back mit v_2 85 m/s @ SL

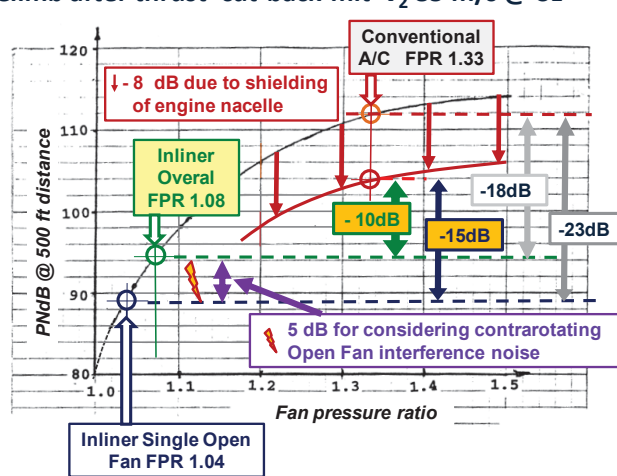

Fig 24. Reduction of the perceived fan noise in PNdB depending on the fan pressure ratio at a distance of 500 ft for initial climb with thrust cut-back after having passed the minimum acceleration altitude of 400ft. The baseline fan reaches a FPR of 1.33 while the Inliner's single fan's FPR is only 1.04. This initially leads to a noise reduction of -23dB. If the former FPR of 1.33 is compared with the Inliner's Fan system's FPR of 1.08 the noise reduction equals -18 dB. The engine's nacelle is expected to lead to a further shielding of fan noise at the baseline aircraft, resulting in an assumed outward noise reduction of -8db. Taking this into account as an updated reference the Inliner's noise reduction for the fan noise is still -10 dB, which equals a reduction in perceived intensity compared to the baseline aircraft at climb of around - 50%, already taking into account that the Fans at the Inliner operate open, thus without being mantled. Furthermore interference noise of the two counter-rotating fans has also been considered in this result by artificially increasing the FPR at the single rotors. By this around +5dB or roughly +30% in perceived noise intensity (see Figure 22), is added to a single fan with respect to the interference of both counter-rotating rotors.

Figure 22 and 23 show the noise reduction of the outside perceived fan noise analogically for the flight states of initial climb and for the final approach. It has been found out in [28], that the interference noise level of the fan

Approach v_{APP} 140 kt @ SL

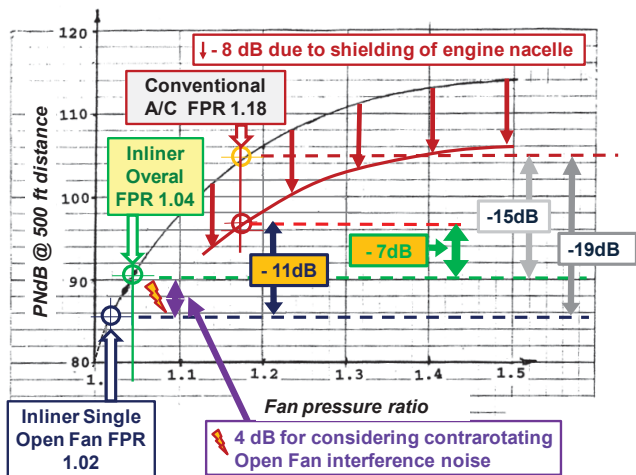

Fig 25. Reduction of perceived fan noise in PNdB depending on the fan pressure ratio at a distance of 500 ft for the final approach stage. The baseline fan reaches a FPR of 1.18 while the Inliner's single fan's FPR is only 1.02. This initially leads to a noise reduction of -19 dB. If the former FPR of 1.18 is compared with the Inliner's Fan system's FPR of 1.04 the noise reduction equals -15 dB. The engine's nacelle at the baseline aircraft, resulting in an assumed outward noise reduction of -8db.

Taking this into account as an updated reference the Inliner's noise reduction for the fan noise is still -7 dB or roughly -40% in perceived intensity (see Figure 22), already taking into account that the Fans at the Inliner operate open, thus without being mantled. Furthermore interference noise of the two counter-rotating fans has also been considered in this result by artificially increasing the FPR at the single rotors. By this around +4dB or roughly +25% in perceived noise intensity (Figure 22), is added to a single fan with respect to the interference of both counter-rotating rotors.

system, formed by two counter-rotating fans, is a function of the FPR of one single fan, which forms this fan system. The lower the FPR of one single fan, the lower the interference noise of the overall fan system.

There is a second approach to roughly estimate the noise level of a specific fan. It is known, that most of the noise is generated at the tips of the blades, as speed here is highest. Hence, the noise level depends on the tip-Ma number of the fan blades. The lower the blade-tip Ma-number, the lower the noise generated. For this reason a subsonic Ma-tip number would be strongly desirable, but has not been achieved in fans of current turbofan-engines, so far.

In the scope of the "Silencer" research project a high bypass ratio (BPR 12), low noise, optimized fan has been examined. This features a blade tip speed at take-off of only around 1.0, which is remarkably lower than that of the baseline aircraft – here Ma 1.51.

With the "Silencer" Fan a reduction in fan noise of 10-12dB has been expected. The Inliner Open Fans' tip speed is even lower and equals 0.77 at take-off or 0.58, if blade sweep and taper of the fan blades is also considered to obtain the effective tip-Ma number.

So finally fan noise reduction at the Inliner aircraft might be even higher, than the former predicted -6db for take-off and -10dB for climb. *Interference noise, however, still*

bears some uncertainties, that have to be considered carefully in further research studies.

It should be underlined that the noise reduction is shown in minus delta dB for the relevant flight stages of take-off run, climb and landing in reference to the baseline turbofan-propelled aircraft. The noise deltas are here stated for a specific distance of 500 ft exemplary. However the shown noise deltas are not limited to this specific distance as they show in general a basic quality in noise reduction. Therefore noise deltas will similarly show up also at greater distances or will there be even advantageously higher.

Finally, some relevant remarks regarding the design of the Open Fans of the Inliner in terms of the noise level generated and in terms of differences to the design of open propulsors, so far known in aviation, should be summarized.

The Open Fan of the Inliner has a completely own characteristic in noise, which is neither comparable to a fan, a propfan nor a propeller. Because of its specific design it will have more similar noise characteristics to a fan (but lower in its noise intensity, however it is dismantled) because of certain reasons:

The number of blades, here 36, is more characteristic to a fan. It is not comparable to a propfan or the "Open Rotor" architecture as they are so far known to have only 6-8 highly loaded blades. Nor is comparable to a propeller, which has 2-8 blades in general and one single prop blade is around 2.5 to 3.0 times longer in its span. Thus, as the fan blades are more compact at the Open Fan of the Inliner, vibrations could not as easily get in resonance like they could get with relative large spans of propeller-blades.

The Inliner fan-blade's length is comparable to that of conventional turbofan-engines, but blade tip-speed is significantly lower (by a factor of around 2). Both Open Fans of the Inliner will be in total subsonic flow conditions at take-off, climb and landing. That is why noise generation of the Inliner's Open Fans will be remarkably lower than of conventional fans.

Due to the enlarged circumference of one fan of the Inliner, resulting from the special architecture with the fans encircling the fuselage, the distance between two sample blades at the Inliner is significantly larger than that of two blades at a conventional reference engine. This has the effect that vortexes of a first blade will not interfere that easily with the second blade of the same Open Fan.

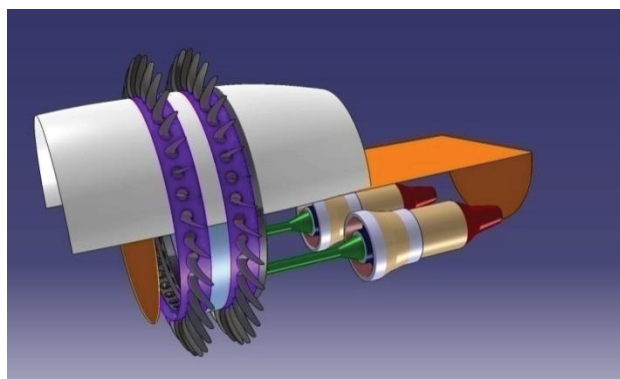

Fig 26. The two Open Fans are completely different from former known Open Rotor configurations as they feature a significantly higher number of blades and rotate remarkably slower due to the reduction gear with tip speeds only around Ma 0.77 at climb, which makes them very quiet.

For the ground noise measured at the overfly point and in general considering the noise footprint on the ground, a large advantage rises from the special architecture of the Open Fans encircling the fuselage. This results in - that approximately one half of the noise generated by the fans will not reach the ground as it is shielded by the fuselage.

For noise optimization the second Open Fan downstream the first Fan could have a slightly smaller overall diameter and a different blade number in order to avoid interference (tip vortexes) and resonance effects.

	Cruise	Initial Climb
Flight speed v in m/s	232	85
altitude ft	25 000	50
Ma in flight/ incoming Ma @ fans	0,75/ 0,77*	0,25/ 0,27*
Outer-/ Inner diameter D_o/D_i	6,2 m / 4,5m	
Hu- to Tip ratio D_i / D_o	0,725	
Revolution rpm	720	740
Performance factor of the airscrew $J=v/nD$	3,191	1,142
Thrust generated N	21 482	68 557
Number of blades	36	
Blade pitch at 75%	58,5°	35,8°
Blade-Tip Ma/ effective Ma including 55 % blade tip sweep - as existing at the A400m Propeller [15]	1,078/ 0,816	0,765/ 0,579
Taper ratio/ blade sweep	0,25 / 55°	
C_T	0,184	0,264
C_P	0,664	0,424
C_S	3,446	1,357
Fixed Ratio of reduction gear shaft to fan	11,6 :1	
Single Open Fan Efficiency	0,886	0,714

Fig 27. Characteristic design parameters of a single Open Fan Design for the flight states of Initial Climb and Cruise as one example of several studies [19]

* the Ma number of the incoming flow is increased by dMa 0.02 due to the suppression effect of the fuselage; The ratio of take-off and continuous climb rpm is the same like with the TP 400, powering the Airbus A 400 M

7.1.3 Noise of the core engine part

The third general type of engine noise is generated in the core of the engine. This includes compressor noise (without fan), noise from the combustion chamber and noise from the turbine stage. Regarding its intensity, this kind of noise is generally not very dominant or relevant, except to a limited extent on final approach.

Compared to the reference aircraft of the A320 this noise is significantly reduced as well. This is mainly because of the embedded installation of the turboprop engines in an unpressurized area of the belly. In general the noise generated is shielded by the outside fairings of the aircraft due to the embedded architecture. Furthermore, there is plenty of space available inside the belly around the engines that can be used for the installation of shielding materials e.g. special honeycomb structures. As the engine is not outside of the aircraft, there will be no additional aerodynamic penalty resulting from enhancing the noise shielding and

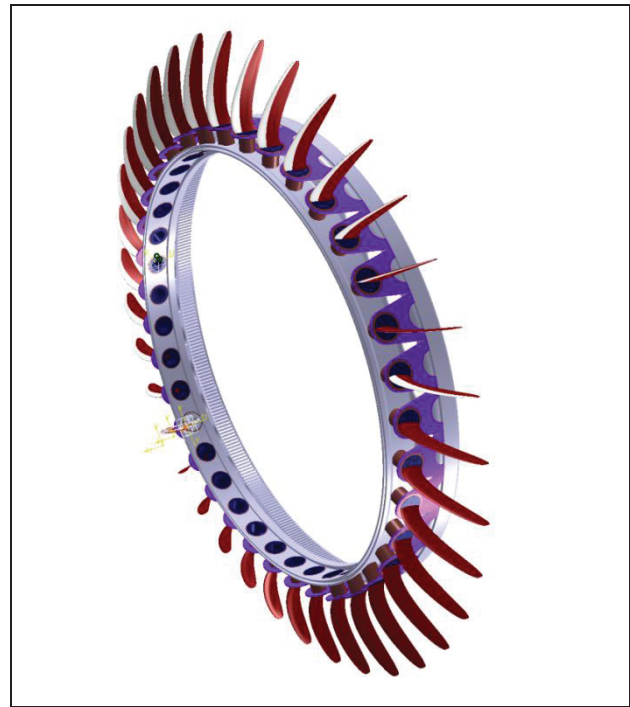

Fig 28. Example Open Fan Design for the Inliner with integrated gear ring, featuring 36 variable-pitch fan-blades, here shown without fairings

its increase in dimension and volume. By this, the noise generated from the core of the turboprop engines is estimated to be further lowered by additional -10 dB, which equals a reduction in outside perceptible noise level of around 50 %.

7.1.4 Overall outward noise reduction of the Inliner configuration

Summarizing the effects of these three types of noise abating measures, a *first approach* can be made to estimate a *rough figure for the overall reduction in outward noise level* of the Inliner. The noise component's reductions, here shown in deltas dB, are:

Noise due to the exhaust jet:	- 22 dB (all flight stages)
Noise due to the Open Fans:	- 10 dB (climb)
Noise of the engine core:	- 10 dB (all flight stages)

As a first and very basic assumption it can be assumed that the different types of noises account to the overall outward noise level to the same extent. This is a very conservative and safe assumption for the Inliner as with the reference aircraft noise due to the exhaust gases (nozzle jets) is clearly dominating and its share will be more than one third at take-off and climb. At the same time reduction of this type of noise with the Inliner is highest. So in reality the overall noise reduction for the Inliner will probably be even higher.

With the help of a simple dB calculator the different deltas can then be superposed in order to get an *overall delta of here -22,5 dB*. As Figure 22 shows, this means that the outside perceptible noise level is reduced in its intensity by more than 75 % or by $\frac{3}{4}$. This means the Inliner's perceptible noise level is only less than $\frac{1}{4}$ of the reference aircraft.

8 EXTRA WEIGHT DUE TO THE PROPULSION ARCHITECTURE

In the following the extra weight due to the novel propulsion architecture of the Inliner should be figured out. In comparison to the baseline aircraft on the one hand there will be components, which will be additionally installed, leading to extra weight, on the other hand there will be

parts, which are not necessary any more and could be dismantled from the aircraft.

First the additional weight for the installation of one Open Fan system is calculated, here without the driving engine. Corresponding to table 29 the weight of one fan system is 3900kg, which approximately equals the weight of one equipped engine with pylon but without nacelle of the standard reference aircraft.

Component and total number of components installed	Total volume from CAD	Material	Mass density	Mass of single component	Total mass
01 integral rotating ring structure	0,426 m ³	Titan alloy	4460 kg/m ³	1900 kg	1900 kg
36 outer bearing sleeves for the blades	0,021 m ³	Titan alloy	4460 kg/m ³	2 kg	76 kg
36 supporting links for the fan blades	0,079 m ³	Aluminium alloy	2710 kg/m ³	6 kg	214 kg
36 Fan-blades	0,086 m ³	Titan alloy CfK	4460 kg/m ³	6 kg	216 kg
36 shaft and connection of fan blades	0,021 m ³	Titan alloy	4460 kg/m ³	2,6 kg	94 kg
36 blade-actuators	estimated			6 kg	216 kg
Accessoires	estimated			-	70 kg
Total weight of rotating ring					2786 kg
Bearing units fixed to the fuselage	estimated			8 x 40 kg + 70 kg	390 kg
Lubricants	estimated			-	50 kg
Aerodynamic fuselage-mounted fairings up- and downstream of the Open Fans	0,071 m ³ per every single meter circumference of fuselage, CFRP/ GRP		1500kg/m ³	4 m x 106 kg/m	425 kg
Total mass of static, thus fixed portion to the fuselage					865 kg
1 Hollow transmission shaft of 0,17 m diameter	-	Titan alloy	4460 kg/m ³	16 kg/m 4 m	64 kg
2 Shaft bearings	-	-	estimated	21 kg	42 kg
Fairings if needed	-	-	estimated	20 kg	20 kg
1 bevel gear	0,021 m ³	Titan alloy	4460 kg/m ³	130 kg	130 kg
Total mass of power transmission section					256 kg
Total mass of ONE Open Fan-System, including rotating - and static portion and transmission section (here still without driving engine and pylon for mounting the engine)					3907 kg

Fig 29. Extra mass due to the installation of ONE Open Fan system at the fuselage of the Inliner without already taking into account its driving engine and the mounting of the driving engine. Thereby the mass of One Open Fan System approximately equals the mass of one equipped baseline engine of the Airbus A320 with pylon but without nacelle.

As a next step the total weight of the propulsion architecture can be figured out on aircraft level. According to figure 30 there will be overall additional weight on aircraft level of around 5125 kg.

the engines. Thus the weight will only be 210 kg compared to 890kg of the reference nacelle. The fuselage fairings, encircling the fuselage up and downstream of the fans, have been calculated separately and added to the weight

installation + removal -	Component	Quantity	Mass of single component	Total delta in mass	Remark
-	Original engine CFM 56 -5B4	2	2380 kg	- 4760 kg	known
+	Europrop Tp 400	2	1980 kg	+ 3780 kg	known
-	At the Europrop TP 400 flange-mounted reduction gear	2	600 kg	- 1200 kg	calculated 6,52 kg/kNM
-	Reference pylon	2	625 kg	- 1250 kg	known
+	New simplified installed pylon	2	375 kg	+ 750 kg	estimated
-	Reference nacelle	2	890 kg	- 1770 kg	known
+	Intake for the turboprop - engine	2	210 kg	+ 420 kg	estimated
+	Total mass of rotating rotor ring (rotating portion of the system)	2	2786 kg	+ 5572 kg	calculated from CAD
+	Total mass of static portion including bearings	2	865 kg	+ 1730 kg	calculated
+	Total mass of transmission section	2	256 kg	+ 512 kg	calculated
+	Additional structural mass due to the reinforcement of the fuselage	1	1400 kg	+ 1400 kg	estimated
+	Additional structural mass due to the reinforcement of the wings	1	1400 kg	+ 1400 kg	estimated
+	Extra weight due to recuperative technical means at the turboprop- engines	2	130 kg	+ 260 kg	estimated by +10% of core engine's mass
-	Fuel savings on a 700 nm standard mission (depending on mission's length)	1	1770 kg	- 1770 kg	calculated by iteration
	Total extra mass of the Inliner compared to the reference aircraft	-	-	+ 5124 kg	Summation

Fig 30. Overall extra mass of the Inliner due to its novel propulsion architecture compared to the reference aircraft Airbus A320-214

The pylons for mounting the engines at the Inliner will feature with 375 kg, compared to former 625 kg, remarkable less weight, mainly because of three reasons. First one turboprop-engine, although it is equipped with recuperative means, is with 2020 kg remarkably lighter than one baseline engine, which weights 2380kg. Furthermore the engine will not be necessarily be attached by a cantilever structure any more, which is unfavorable in terms of lightweight design, and could instead be fixed directly for instance to the central wing box structure, which is already designed to take higher loads. Additionally for the mounting concept it does not have to be taken into account any more, that the pylon is exposed aerodynamically to the outside airflow. This makes the design significantly lighter, too.

As the air intakes of the turboprop-engines need a 6-times smaller diameter, the new nacelles are smaller and only have to be half-sided due to the embedded installation of

of the static portion of the propulsion system.

According to the literature [1,4] regarding the additional weight for the recuperative means at the turboprop-engines there is a broad range stated of 5-24% of the engines's core weight. It will here be assumed to be 10% of the engines's weight, because the recuperative means are significantly easier to be installed due to the increased available volume in the former front cargo area. Additionally the turboprop-engines feature a significantly simpler overall architecture and a lower overall pressure ratio (OPR).

With a simple architecture and lower OPR moreover recuperative means are more effective and comparably lighter. More over they have not be designed that complex, nor are they anymore located directly or very near to the outside airflow inside the nacelles, which cancels the complex requirement of a very narrow cross section of the recuperative measures.

Similar to rear engine mounted airliners, the propulsive

force is directed straight into the fuselage. However, if one Open Fan fails, a reactive moment, resulting from of the Open Fan still in operation, will be applied on the fuselage. For this reason certain reinforcement will be needed to take up the structural loads. This will be considered by a conservative assumption of 1400 kg extra weight for the fuselage.

Due to less fuel being consumed there is also less fuel needed to be stored in the wings. At the same time, because of the omission of engines and pylons there is less weight relieving the wing structure during flight. This could lead to necessary reinforcement of the wing structure as well, which is assumed to weight about 1400kg. An airbus engineer who was involved in the A350 structural wing design commented this as 'being far too much'. Nevertheless, this value is kept as to stay in line with the conservative approach.

Knowing the total additional mass of the propulsion architecture of the Inliner, the additional weights influence on the fuel consumption of the aircraft can be calculated.

According to the Flight Crew Operating Manual [18] of the Airbus A320-214, the additional fuel consumption per 1000 nm, depending on the cruising altitude (FL Flight Level), for an excess load of 1000kg at a maximum take-off weight of 77000kg is stated in the table below for a typical high speed cruise conditions of Ma 0.78.

Cruise Flight Level Ma 0,78	Extra fuel needed per 1000 kg excess weight and 1000 nm
FL 370	80,5 kg
FL 330	74,0 kg
FL 310	54,4 kg
FL 290	43,5 kg

Fig 31. Extra fuel needed per 1000 kg excess weight over MTOW conditions of 77000 kg for typical high speed cruise conditions of Ma 0.78 and per 1000 nm depending of the cruise flight altitude chosen [18].

The additional fuel consumption per 1000kg additional weight for the climb to flight level (uplift) for a MTOW of 77000 kg and typical climb profile of the A320 (climb speeds in sequence of 250 kt/ 300 kt and Ma 0.78) [18] are shown in the table below.

Climb to Cruise Flight Level 250kt/ 300kt/ Ma 0,78	Extra fuel needed per 1000 kg excess weight
FL 370 *	60 kg
FL 330	52 kg
FL 310	43 kg
FL 290	35 kg

Fig 32. Extra fuel needed per 1000 kg excess weight over MTOW conditions of 77000 kg for the uplift of the excess weight at typical climb speed profil of the Airbus A320 of 250 Kt/ 300 kt and Ma 0.78 depending of the cruise flight altitude chosen. * no direct climb at MTOW [18]

During the other phases of the mission - apart from climb and cruise - *no relevant change* in fuel consumption is expected. At take-off and initial climb the engine will any-

way run at maximum take-off thrust and only for a total time of 1 to 2 minutes. While descending, the engines are at idle with constant fuel consumption. Fuel consumption during the approach phase is only slightly higher from idle. Requirements for fuel reserves remain same and anyhow are not flown out – here only the fuel, which is finally consumed, is considered.

For typical stage lengths of the Airbus A320 of 500/ 700 and 800 nm the following total mission fuel is needed according to [18]:

Fuel in kg	500 nm	700 nm	800 nm
Taxi out 15 min/ in 5 min	186	186	186
TO and climb	1261	1546	2067
Cruise	2106	2680	3640
Descend	117	117	117
Total Fuel Consumed	3670	4529	6010

Fig 33. Mission fuel needed for typical stage lengths of the Airbus A320 of 500/ 700 and 800nm [18]

In sequence a typical 700 nm short range standard mission will be considered in detail to determine what additional fuel is needed as a consequence of the increased weight of the propulsion system of the Inliner. The duration of a 700 nm missions is 1 h and 15 min in total. Assuming a cruise flight level of 33000 ft the total mission fuel equals 4530kg. In the scope of this mission a distance of nearly exactly 500 nm is flown under cruise flight conditions, while the rest of the distance is for descend, approach and take-off. According to table 31, the additional fuel consumption during cruise at an altitude of 33000 ft will be 37 kg per 1000 kg additional weight and per 1000 nm cruise.

For the climb to flight level 330 there an additionally 52 kg fuel needs to be added per 1000 kg excess weight according to table 33 for the uplift.

Altogether for the 700 nm mission, here mainly determined by climb and cruise, there will be a total additional fuel needed of 89 kg per 1000 kg extra weight.

In relation to the former mission fuel of 4530 kg of the baseline aircraft for this sector, this is a percental increase of 1.965% or nearly exactly 2.0 percentage points per ton extra weight.

Further calculations, considering various different load factors of the aircraft and different cruising altitudes the additional fuel for a standard 700 nm mission can be assumed to be in the range of 1.8% to 2.5% per 1000kg extra load.

For the final evaluation of the extra fuel consumption of the Inliner the average value of 2.2% additional fuel burn per 1000 kg will be chosen from this spectrum as to be representative.

Thus for the extra weight of 5125 kg of the Inliner due to its characteristic propulsion architecture, there will be an additional fuel burn of initially +11.3% or 510 kg.

9 FINAL FUEL SAVINGS

Finally it should be figured out, which fuel savings in total can be reached with the new aircraft configuration Inliner on a standard short range mission of 700 nm. The savings will be calculated with special regards to the cruise flight state, as under these conditions individual contributions to the overall savings could be figured out at best. Therefore, it becomes highly probable, that for the real standard mission the fuel savings are even slightly higher. One reason is that the climb phase represents an important portion of the total mission and, that in climb fuel savings are even remarkably higher than in cruise, because of the variable-pitch fan, which allows to better adopt the thrust generation in relation to the climb speed in terms of fuel efficiency.

For a standard short range mission according to [21,22] 3% fuel savings due to electric taxiing can be reached, already considering the extra weight of the taxi system.

It is expected that for standard short range aircraft overall structural weight savings will contribute to another 10% of the potential fuel savings [1]. Here, in a conservative approach only 5% fuel savings are assumed which could be already have been realized at the A320 NEO design at this level.

Aerodynamic enhancements should include the installation of winglets/sharklets and a reshaping of the bellyfairing, leading to 4% of mission fuel savings. Also these enhancements and fuel improvements are already realistically covered by the A320 NEO design.

Because of the omission of pylons and nacelles, the integration of a more simple high lift system becomes easier and lighter. At the same time the "clean" wing can be used for natural laminar flow technologies (NLF), enabling broader laminar flow portions on the wing. The drag reduction results in potential fuel savings in the range of 10-12% [1]. It should be expected that another 3% fuel savings can be reached out of the potential of this technology in a first step.

With the help of an integrated diffusor, which surrounds the fuselage downstream the Open Fans system, the extra speed of the fluid induced due to the fans can be converted according to the principle of pressure recovery at least partly into thrust. By this, components downstream the fan system are not any more exposed to a slightly higher dynamic pressure respectively, which lowers the drag level. The drag reduction leads to a further fuel saving of 4.1% at best.

As at this time the effectiveness of the diffuser is still uncertain, all fuel savings accounting to this technical measure are marked as preliminary by blue values.

In order to realistically realize a lightweight design, the variable-pitch mechanism of the Open Fans will probably cover one single actuator per blade. Hence no structural heavy integrated ring is additionally necessary for the adjustment of the blades. In a differing operation mode this enables a certain blade of the Open Fan to be individually controlled in pitch depending on its actual circular

position. By doing this according to a concept which is known as individual blade control by helicopters this enables a vectorization of the thrust of the fans which can be advantageously used for supplementary trim and control of the aircraft. During cruise the horizontal stabilizer can then be relieved in load, because downlift is then produced mainly by the vectorized rotor system. This can contribute to minor fuel savings of 0.5%. This value in response to this special and complex technical measure is marked in blue as optional, too.

The obtainable savings in mission fuel due to aft fuselage boundary ingestion (BLI) should be around 10%, when ingestion is at the very rear of the fuselage [33]. At a longitudinal fuselage position, shown with the Inliner concept, in front of the wings, fuel savings, resulting from fuselage boundary ingestion, are expected to be minimally 5% [33].

In total the novel propulsion architecture of the Inliner configuration results in additional weight of around 5125kg on aircraft level. This extra weight does affect the fuel performance of the aircraft initially in an unfavorable way and accounts for +11.3% of extra fuel requirement, which is considered in the subsequent performance calculations. However the fuel savings outweigh this extra fuel needed, resulting later in a substantial efficiency gain and significant fuel savings on aircraft level.

All fuel saving potentials and fuel deltas, mentioned, refer to the same reference aircraft of the Airbus A320, representing with its CFM engines the technology level of the year 2000 and are therefore in line with the ACARE reference. Thus the single deltas can be superposed in order to get the final total mission fuel savings on aircraft level, which is shown in figure 34.

Finally the total fuel savings for a 700 nm standard mission are 39.7% (up to 44.3%, if further optional measures are additionally applied, marked by blue figures). With these values it seems probable and realistic that the ambitious ACARE Vision 2020 targets of 50% fuel savings can be reached on aircraft level (in combination with further air traffic measures).

Furthermore the ACARE target of 20% fuel gain on engine level will be reached, too.

The positive snowball effect of lower aircraft weight due to less fuel consumption which in turn further lowers the aircraft weight and thereby the fuel consumption has not been considered so far. As a result fuel savings in reality would probably be slightly higher.

Furthermore there exist some further technical detail-measures, which are up to now not considered and applied, but which bear the potential for further enhancing fuel efficiency at least slightly.

10 SUMMARY AND CONCLUSION

In this technical paper a novel aircraft configuration for a superefficient aircraft is developed within an integrated approach. The "Inliner", a novel standard short range aircraft, is mainly characterized by a unique architecture, consisting of a set of two counter-rotating Open-Fans positioned in-line and thereby encircling the fuselage. Each Open-fan is gear-driven by an ultra-high efficient turboprop- engine, known from state-of-the-art turboprop aircraft. The two turbines are placed in a semi-buried installation in the unpressurized belly of the aircraft ahead of the main landing gear bay under sufficient cooling. The characteristic propulsion architecture bears not only a significantly enhanced efficiency and advanced aerodynamics but also enables further and optional synergies like fuselage boundary ingestion, a natural laminar flow wing, easy integration of high-lift systems and additional drag reduction by exhaust emission at the bottom and rear region of the contracted aft fuselage.

Reduction in overall mission fuel for a 700 nm standard mission compared to the year 2000 reference aircraft	
- 18.7 %	Enhancement of the propulsive efficiency (by 23%), effecting the specific fuel consumption thus the mission fuel
- 5.8 %	Reduction in drag of 5.8% due to the novel propulsion architecture and the omission of pylons and nacelles
- 6.0 %	Enhancement of 6.4% regarding the thermodynamic efficiency by recuperative means in response to a larger space available for integration and an increased effectiveness on turboprop-engines
- 5.0%	Predicted enhancement by fuselage boundary layer ingestion at this longitudinal fuselage position [33] (BLI Boundary Layer Ingestion)
optional* (not certain) - 4.1%	Diffusor, encircling the fuselage downstream the fans, or diffuser function of contracted fuselage for pressure recovery
- 35.5% - 39.6% *	Intermediate result: savings in mission fuel due to the novel propulsion architecture blue: including optional tech. measures
- 5.0 %	Beneficial lowering the necessary overall thrust level by structural weight savings on aircraft level without considering the additional weight of the propulsion system [26]
+ 11.3%	Extra fuel needed due to the extra weight, caused by the novel architecture of the propulsion system of 5.1 t
- 4.0 %	Enhancement of the wing aerodynamics by winglets installation and a reshaping of the bellyfairing (like at the A320 NEO)
- 3.0 %	Fuel Savings due to Electric Taxiing
- 3.0 %	Reduction in drag due the installation of a partly natural laminar flow concept at the outer wings (potential up to 10-12%)
- 0.5% optional*	Thrust vectorization by individual blade control at the Open Fans to minimize trim drag and stabilizer's downlift in cruise flight
- 39.7% - 44.3% *	Total mission fuel savings blue* including optional tech. measures

Highly increased mass flow rates can be created by the Inliner's slow rotating geared Open Fans, with a larger thrust area, resulting in lower Fan Pressure Ratios (FPR) of 1.04 for the single rotor and 1.09 for the rotor system in cruise (rounded) as well as ultimate lower fan tip speeds of Ma 0.77 at climb. Apart from a significantly enhanced efficiency (comparable fuel effective BPR near 50 : 1; geometric BPR 24.5 : 1), noise emission levels at take-off and climb have been shown in our calculations to be from - 67% up to more than -75% lower in comparison to the reference aircraft, the Airbus A320.

Remarkably improved fuel efficiency of the Inliner is first achieved by a significantly increased propulsive efficiency (as a result of its counter-rotating fan engine architecture), second by its improved thermodynamic efficiency (as a result of special recuperative technical measures on the two turboshaft-engines) as well as third by its improved aerodynamic efficiency (resulting from the omission of engine pylons and nacelles and a clean wing). The combined measures of this integrated approach result in a significant improved efficiency and fuel savings of 40-45 % on a standard 700 nm mission.

The maximum NO_x emission levels will be at least 23% lower than with the reference aircraft, mainly because of a lower OPR of the turboprop engines. The investigations on extraordinary operational circumstances of this aircraft configuration, such as rotor burst foreign object damage, maneuvers of high-angle of attack, precession effects and special engine and rotor failure considerations have also shown positive results, but could not be presented in the scope of this paper.

Altogether, as fuel consumption respectively CO₂ emissions can be reduced by 40-45%, NO_x levels are up to 23% lower and the outside noise level could be dropped by more than 2/3s, the Inliner will tend to comply with the ACARE Vision 2020 targets. As current turboprop-engines can be easily replaced by future hybrid-or full electric engines, the Inliner can be not only seen as a next generation superefficient short range aircraft, but also enables future research and realization of electric and hybrid-electric aircraft and propulsion concepts.

Thus present values for a reduction in fuel consumption, noise and emissions might be seen as start values, which can be further optimized in future by time. This has been comparably done with the present and existing airliner configuration, which has been being optimized over 60 years, in which 2/3s of the initial fuel consumption [1] could have been saved. Therefore the Inliner aircraft configuration, even though already representing a superefficient airliner, bears further potential, both for outstanding research and for even further future realistic enhancements in fuel efficiency and quietness beyond.

Fig 34. Overall fuel savings off he Inliner configuration compared to the reference aircraft Airbus A320 for a standard 700 nm. * also including supplemental optional technical means, marked in blue

Referenzen

- [1] T. C. Gmelin, G. Hüttig, O. Lehmann 2008. *Zusammenfassende Darstellung der Effizienzpotentiale bei Flugzeugen unter besonderer Berücksichtigung der aktuellen Triebwerkstechnik sowie der absehbaren mittelfristigen Entwicklungen*, FKZ UM 07 06 602/01, im Auftrag des Bundesministeriums für Umwelt, Naturschutz und Reaktorsicherheit
- [2] N. T. Birch, M. C. 2000. *Vision: The Prospects for Large Civil Aircraft Propulsion, Advanced Propulsion Systems Design*. Rolls Royce plc, Derby, PO Box 31
- [3] ACARE 2001. *European Aeronautics: A Vision for 2020*, Advisory Council for Aeronautics Research in Europe.
- [4] W. J. G. Bräunling. 2004. *Flugzeugtriebwerke*. Springer Verlag, 2. Auflage.
- [5] Greener by Design. 2005. *Mitigating the Environmental Impact of Aviation: opportunities and Priorities*, Royal Aeronautical Society.
- [6] Greener by Design. 2007. *Annual report 2006-2007*, Royal Aeronautical Society
- [7] European Commission. Flightpath 2050 Europe's Vision for Aviation. Aerodays, Madrid, 2011. (last accessed April 2013) obtainable: <http://ec.europa.eu/transport/air/doc/flightpath2050.p>
- [8] LTH Luftfahrttechnisches Handbuch, Propelleraerodynamik, Ausgabe A
- [9] Purdue university 2013: Website Purdue University School of Aeronautics and Astronautics Research (last accessed August 2013) obtainable: <https://engineering.purdue.edu/AAE/Research/Propulsion/Info/jets/advanced/propfan>
- [10] Rolls Royce 2007. *Vision: DREAM- Validation of radical Engine Architecture Systems*, Presentation 15.01.2007.
- [11] B.H. Little; D.T. Poland; H.W. Bartel; C.C. Withers; P.C. Brown. Juli 1989. *Propfan Test Assessment (PTA)*, Final Project Report, Nasa Contractor Report 185138, Lockheed Aeronautical Systems Company, Hamilton Standard Division.
- [12] image taken from (last accessed August 2013): rechts: Abbildung, entnommen <http://www.turbosquid.com>
- [13] image taken from (last accessed August 2013): <http://www.ainonline.com/aviation-news/>
- [14] Airbus. May 2011. *A320 Airplane Characteristics for Airport Planning*. Airbus S.A.S., Blagnac. Customer Services. Technical Data Support and Services.
- [15] A. Johanning; D. Scholz Aero-Aircraft Design and Systems Group, HAW. *Novel low-flying Propeller-Driven Aircraft Concept for Reduced Operating Costs and Emissions*.
- [16] image taken from (last accessed August 2013) : <http://www.flugzeug-bild.de/name/einzelbild/number/8595/kategorie/Passagierflugzeuge~Iljuschin~IL62.html>
- [17] Vorlesungsskript Flugzeugentwurf I + II, Rudolf Voith-Nitschmann, IFB Institut für Flugzeugbau, Universität Stuttgart
- [18] *A 319/A320/A321 Flight Crew Operating Manual*. Volume 3 Flight Operations. Airbus, Blagnac. Customer Service Directorate, Technical Documentation Services (AI/SE-D)
- [19] website Dr. Martin Hepperle, Javaprop applet (last accessed August 2013): <http://www.mh-aerotoools.de/airfoils/javaprop.htm>
- [20] Müller, F. 2003. *Flugzeugentwurf*. Neue flugtechnische Reihe: Band 4, Verlag Dieter Thomas
- [21] Airbus S.A.S. Jan 2013. *Flight Airworthiness Support Technology, Fast 51*. Airbus S.A.S. Blagnac. (last accessed April 2013) obtainable: http://www.airbus.com/support/publications/?eID=dam_frontend_push&docID=28153
- [22] Schwarze, M. C. 2013. *Operation and Performance Assessment of Novel Electric-Wheel-Driven Hybrid-Electric Propulsion Systems on Standard Short Range Passenger Airplanes*. DLRK 2013, 62th Deutscher Luft- und Raumfahrtkongress. Stuttgart, Germany
- [23] image taken from (last accessed August 2013): http://commons.wikimedia.org/wiki/File:South_East_Airlines_Tupolev_Tu-154.jpg
- [24] F. Brophy, Pratt and Whitney Canada Corp. 2013. *Propulsion Challenges & Strategies for a more Sustainable Aviation*. CASI AERO 13, 60th Aeronautical Conference. Toronto, Canada

[25] R.W. Harris; R.D. Cuthbertson, General Electric Company, Boeing Commercial Aircraft Company.1987. *UDF/ 727 Flight Test Programm.*, AIAA 1987 Joint Propulsion Conference

[26] Schwarze, M. C. 2013. Angepasste Flugzugkonfigurationen für die energieeffiziente Open-Rotor Integration auf zukünftigen Kurzstrecken-Verkehrsflugzeugen. DLRK 2013, 62thDeutscher Luft- und Raumfahrtkongress. Stuttgart, Germany

[27] Michael Schmid. Studienarbeit, Institut für Luft-und Raumfahrt, Technische Universität Berlin: Entwicklung eines Programmmoduls zur Prognose des Lärms von Strahltriebwerken im Flugzeugvorentwurf

[28] Alexander Bolonkin 1999. NASA Dryden Flight Research Center: A High Efficient Fuselage Propeller („Fusefan“) for Subsonic Aircraft, 1999-01-5569, 1999 World Aviation Conference October 19-21, San Francisco, CA, USA

[29] image taken from (last accessed August 2014):
http://upload.wikimedia.org/wikipedia/commons/a/af/Boeing_Concept_Supersonic_Aircraft_-_Icon-11.jpg

[30] image taken from (last accessed August 2014):
<http://www.spiegel.de/wissenschaft/technik/neuer-ueberschalljet-airbus-plant-oeko-concorde-a-769255.html2013.jpg>

[31] image taken from (last accessed August 2014):
<http://www.huhmagazine.co.uk/2251/airbus-concept-cabin>

[32] image taken from (last accessed August 2014):
<http://www.airliners.net>

[33] Dr. Manuel Kessler, Arbeitsfeld Hubschrauber-aerodynamik und Aeroakustik, IAG Institut für Aerodynamik und Gasdynamik der Universität Stuttgart, persönliches Gespräch und Einschätzung vom 17.06.2014

[32] image taken from Bauhaus Luftfahrt e.V. München(last accessed August 2014):
<http://www.bauhaus-luftfahrt.net/archiv/ila-2014-bauhaus-luftfahrt-praesentiert-2014epropulsive-fuselage2014>

[33] table taken and translated to German from the following website (last accessed Mai 2015):
<http://www.sengpielaudio.com/Rechner-pegelaenderung.htm>